

9. INSTALLATION / WIRE CONNECTION GUIDE

CONTENTS

1) Before Starting	16
2) Package Contents	16
3) General Cautions	16
4) Cautions on Installation	16
5) Installing the Source Unit	16
6) Cautions on Wiring	17
7) Sample Systems	17
8) Wiring and Connections	18
9) Connecting the accessories	18

1) Before Starting

1. This set is exclusively for use with a negative ground 12 V power supply.
2. Read these instructions carefully.
3. Be sure to disconnect the battery "terminal" before starting. This is to prevent short circuits during installation. (Figure 1)

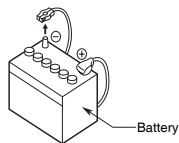

Figure 1

2) Package Contents

Source unit	1	Screws M4x30 mm	6
Hole block seal (black)	1	Power supply cable	1
Support strap	1	Owner's manual	1
M4 Nut	1	Warranty card	1
M4 washer	2	Installation template	1

3) General Cautions

1. Do not open the case. There are no user serviceable parts inside. If you drop anything into the unit during installation, consult your dealer or an authorized **Clarion** service center.
2. Use a soft, dry cloth to clean the case. Never use a rough cloth, thinner, benzine, or alcohol etc. For tough dirt, apply a little cold or warm water to a soft cloth and wipe off the dirt gently.

4) Cautions on Installation

1. Prepare all articles necessary for installing the source unit before starting.
2. Install the unit within 30° of the horizontal plane. (Figure 2)
3. If you have to do any work on the boat body, such as drilling holes, consult your boat dealer beforehand.
4. Use the enclosed screws for installation. Using other screws can cause damage. (Figure 3)

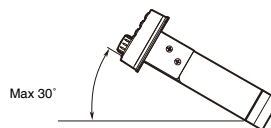

Figure 2

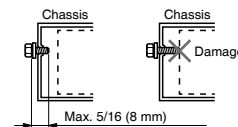

Figure 3

5) Installing the Source Unit

• Marine stereo mounting dimensions

Using the supply template to cut the hole and drill the holes. (Figure 4)

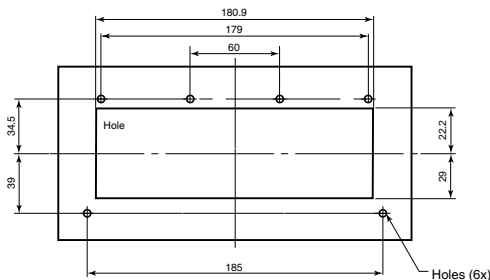

Figure 4

CAUTION
Drill appropriately prepared holes at the 6 places for fixing the screw depending on the materials and plate thickness of the panel.

1. Insert the source unit into the cutout hole until to the end. (Figure 5)
2. Using the supply screws (4 x 30) to secure the source unit. (Figure 5)
3. Using support strap to secure the source unit on the back side by supply M4 nut. (Figure 5)

Notes:

1. Some boat models require special mounting kits for proper installation. Consult your **Clarion** dealer for details.

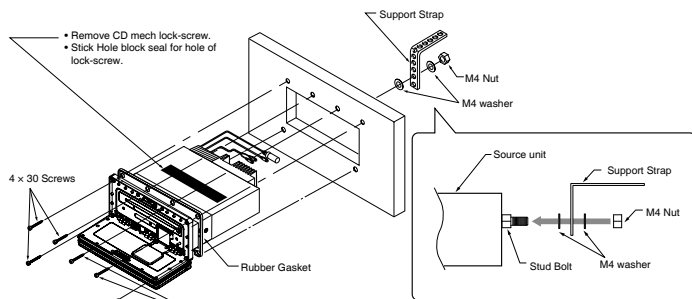

Figure 5

Note:
Confirm that the rubber gasket is fastened securely to the base panel.

6) Cautions on Wiring

1. Be sure to turn the power off when wiring.
 2. Be particularly careful where you route the wires. Keep them well away from the engine, exhaust pipe, etc. Heat may damage the wires.
 3. If the fuse should blow, check that the wiring is correct. If it is, replace the fuse with a new one with the same amperage rating as the original one.
 4. To replace the fuse, open the lock on the source unit side, remove the old fuse and insert the new one. (Figure 6)
- * There are various types of fuse cases. Do not let the battery side terminal touch other metal parts.

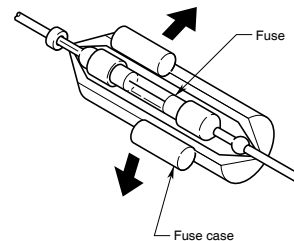
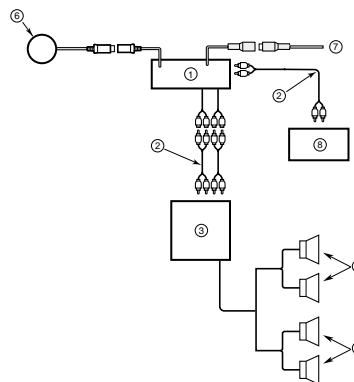

Figure 6

7) Sample Systems



1	Source unit
2	RCA extension cable (sold separately)
3	4-Channel power amplifier
4	Front speakers
5	Rear speakers
6	Wired remote control unit
7	SiriusXM-Connect Vehicle Tuner
8	AUX

8) Wiring and Connections

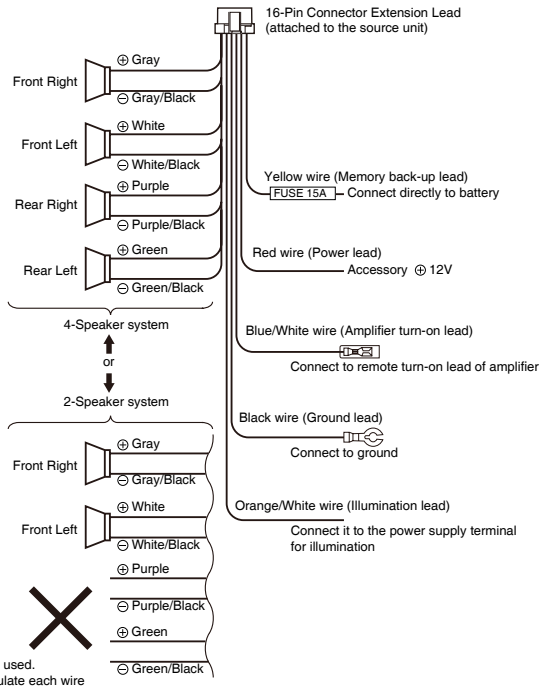
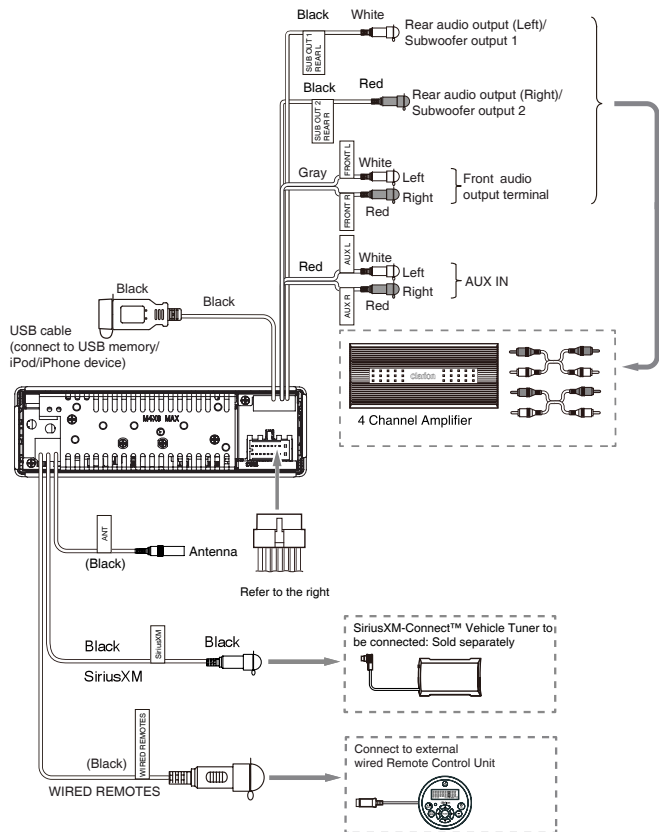

9) Connecting the accessories

• Connecting to the external amplifier

External amplifiers can be connected to the 4 channel RCA output connections. Ensure that the connectors are not grounded or shorted to prevent damage to the unit.