

clarion®

Owner's manual & Installation manual
Mode d'emploi et manuel d'installation
Benutzerhandbuch & Installationshandbuch
Manuale dell'utente e manuale di installazione
Gebruikershandleiding en installatiehandleiding
Manual de instrucciones y de instalación
Ágar- & installationshandbok
Instrukcja obsługi i instalacji
Εγχειρίδιο Λειτουργίας & Εγκατάστασης

CZ102E
CZ102ER
CZ102EG

CD/MP3/WMA RECEIVER
LECTEUR CD/MP3/WMA
CD/MP3/WMA-RECEIVER
SINTOLETTORE CD/MP3/WMA
CD/MP3/WMA-ONTVANGER
RECEPTOR CD/MP3/WMA
CD/MP3/WMA-RECEIVER
ODTWARZACZ CD/MP3/WMA
z interfejsem
CD/MP3/WMA ΔΕΚΤΗΣ

CAUTIONS:

This appliance contains a laser system and is classified as a "CLASS 1 LASER PRODUCT". To use this model properly, read this Owner's Manual carefully and keep this manual for your future reference. In case of any trouble with this player, please contact your nearest "AUTHORIZED service station". To prevent direct exposure to the laser beam, do not try to open the enclosure.

CAUTION

USE OF CONTROLS OR ADJUSTMENTS OR PERFORMANCE OF PROCEDURES OTHER THAN THOSE SPECIFIED IN THE OWNER'S MANUAL MAY RESULT IN HAZARDOUS RADIATION EXPOSURE.

ADVARSEL.

Denne mærkning er anbragt udvendigt på apparatet og indikerer, at apparatet arbejder med laserstråler af klasse 1, hvilket betyder, at der anvendes laserstråler af svageste klasse, og at man ikke på apparatets yderside kan blive udsat for utilsladelig kraftig stråling.

APPARATET BØR KUN ÅBNES AF FAGFOLK MED SÆRLIGT KENDSKAB TIL APPARATER MED LASERSTRÅLER!

Indvendigt i apparatet er anbragt den her gengivne advarselsmærkning, som advarer imod at foretage sådanne indgreb i apparatet, at man kan komme til at udsætte sig for laserstråling.

OBS!

Apparaten innehåller laserkomponenten som avger laserstråling överstigande gränsen för laserklass 1.

VAROITUS

Suojakoteloja si saa avata. Laite sisältää laseriodiin, joka lähettää näkymätöntä silmille vaarallista lasersäteilyä.

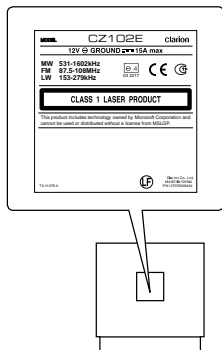
**Contents**

Thank you for purchasing this **Clarion** product.

- Please fully read this owner's manual before operating this equipment.
- Check the contents of the enclosed warranty card and store it in a safe place with this manual.

Contents	1
1. FEATURES	2
2. PRECAUTIONS	2
Front Panel / Generalities	2
Remove the DCP	3
Attach the DCP	3
Storing the DCP in the DCP Case	3
3. CONTROLS	3
Operational Panel	3
Names of Buttons	3
4. CAUTIONS ON HANDLING	4
Handling Discs	4
5. OPERATIONS	4
Basic Operations	4
System Setup	5
Audio Setup	5
Radio Operations	5
Radio Data System Operations	6
CD/MP3/WMA Operations	6
AUX Operations	8
6. TROUBLE SHOOTING	8
7. ERROR DISPLAYS	9
8. SPECIFICATIONS	9
9. INSTALLATION / WIRE CONNECTION GUIDE	10

1. FEATURES

- MP3/WMA compatible with ID3-TAG display
- Front-panel auxiliary input & 2ch RCA output
- "BEAT-EQ" with 3 Band Parametric Equalizer & "MAGNA BASS EX" dynamic bass enhancement

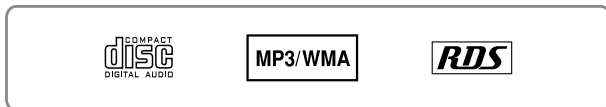

Expanding Systems

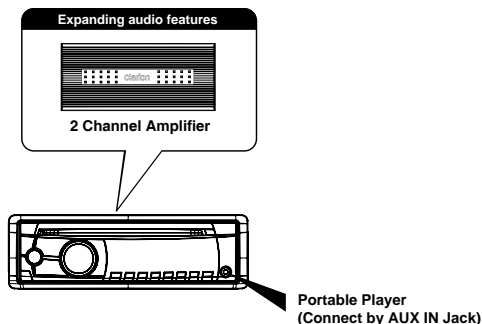

Note:
The items listed outside of the frames are the commercial products generally sold.

2. PRECAUTIONS

⚠ WARNING

For your safety, the driver should not operate the controls while driving. Also, while driving, keep the volume to a level at which external sounds can be heard.

1. When the interior of the car is extremely cold and the player is used soon after switching on the heater, moisture may form on the disc or the optical parts of the player and proper playback may not be possible. If moisture forms on the disc, wipe it off with a soft cloth. If moisture forms on the optical parts of the player, do not use the player for about one hour. The condensation will disappear naturally allowing normal operation.
2. Driving on extremely bumpy or rough roads can cause the disc to skip during playback.
3. This unit uses precision parts and components for its operation. In the event that trouble arises, never open the case, disassemble the unit, or lubricate the rotating parts. Contact your Clarion dealer or service center.

Front Panel / Generalities

For a longer service life, be sure to read the following cautions.

- Do not allow any liquids on the unit from drinks, umbrellas, etc. Doing so may damage the internal circuitry.
- Do not disassemble or modify the unit in any way. Doing so may result in damage.
- Do not let cigarettes burn the display. Doing so may damage or deform the body.
- If a problem should occur, have the unit inspected at your store of purchase.

Cleaning the body

- Use a soft, dry cloth and gently wipe off the any dirt or dust.
- For tough dirt, apply some neutral detergent diluted in water to a soft cloth, wipe off the dirt gently, then wipe again with a dry cloth.
- Do not use benzene, thinner, car cleaner, etc., as these substances may damage the body or cause the paint to peel. Also, leaving rubber or plastic products in contact with the body for long periods of time may cause stains.

Remove the DCP

The control panel can be detached to prevent theft. When detaching the control panel, store it in the DCP (DETACHABLE CONTROL PANEL) case to prevent scratches.

We recommend taking the DCP with you when leaving the car.

1. Press the [SRC / \square] button (1 sec.) to turn off the power.
2. Deeply push in [OPEN] button to unlock the DCP.
3. Hold the side popped out, remove the DCP.

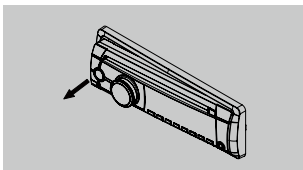

Attach the DCP

1. Hold the DCP and ensure that the panel faces towards you. Set the right side of the DCP into the DCP bracket.
2. Press the left side of the DCP until it locks.

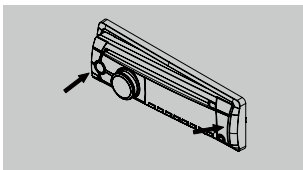

Storing the DCP in the DCP Case

Hold the DCP, as shown in the figure below, and put it into the supplied DCP case.

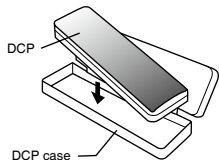

Note:
If the DCP is dirty, wipe off the dirt with a soft, dry cloth only.

CAUTION

- The DCP can easily be damaged by shocks. After removing it, be carefully not to drop it or subject it to strong shocks.
- Once the [OPEN] button is pressed and DCP is unlocked, car vibrations can cause the DCP to fall
- The connector for the main unit and DCP is extremely important. Be careful not to damage it by pressing on it with fingernails, screwdrivers, etc.

3. CONTROLS

Operational Panel

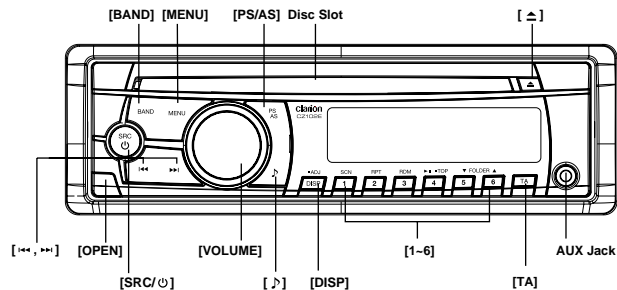

Names of Buttons

[SRC / \square] Button

- Power / Toggle the audio source

[BAND] Button

- RADIO mode – Select tuner band
- MP3/WMA mode – Display switch

[MENU] Button

- MP3/WMA mode – Search function.
- CD mode – No function.
- RADIO mode – PTY select
- AUX mode – No function.

[] (up arrow) Button

- Press to eject disc.

[] (left arrow) [] (right arrow) Buttons

- Previous / next track
- Search (Long press)

[OPEN] Button

- Unlock the front panel.

[PS / AS] Button

- Scan play / Preset scan
- Auto memory store (long press)

[] (down arrow) Button

- Sound effect setting

[VOLUME] Knob

- Adjust volume level / Confirm (press)

[TA] Button

- Traffic announcement

[1-6] Buttons

- [1] Button: Scan play / Preset station 1.
- [2] Button: Repeat play / Preset station 2.
- [3] Button: Random play / Preset station 3.
- [4] Button: Play / Pause / Top play (long press) / Preset station 4.
- [5] Button: Previous folder / Preset station 5. 10 tracks down (long press)
- [6] Button: Next folder / Preset station 6. 10 tracks up (long press)

[DISP] Button

- Display switch
- System setup (long press)

4. CAUTIONS ON HANDLING

Handling Discs

Handling

- New discs may have some roughness around the edges. If such discs are used, the player may not work or the sound may skip. Use a ball-point pen or the like to remove any roughness from the edge of the disc.

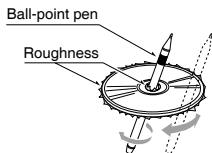

- Never stick labels on the surface of the disc or mark the surface with a pencil or pen.
- Never play a disc with any cellophane tape or other glue on it or with peeling off marks. If you try to play such a disc, you may not be able to get it back out of the player or it may damage the player.
- Do not use discs that have large scratches, are misshapen, cracked, etc. Use of such discs may cause misoperation or damage.
- To remove a disc from its storage case, press down on the center of the case and lift the disc out, holding it carefully by the edges.
- Do not use commercially available disc protection sheets or discs equipped with stabilizers, etc. These may damage the disc or cause breakdown of the internal mechanism.

Storage

- Do not expose discs to direct sunlight or any heat source.
- Do not expose discs to excess humidity or dust.
- Do not expose discs to direct heat from heaters.

Cleaning

- To remove fingermarks and dust, use a soft cloth and wipe in a straight line from the center of the disc to the circumference.
- Do not use any solvents, such as commercially available cleaners, anti-static spray, or thinner to clean discs.
- After using special disc cleaner, let the disc dry off well before playing it.

On Discs

- Never turn off the power and remove the unit from the car with a disc loaded.

CAUTION

For your safety, the driver should not insert or eject a disc while driving.

5. OPERATIONS

Basic Operations

Note:

- Refer to the diagrams in "3. CONTROLS" when reading this chapter.

CAUTION

When the unit is turned on, starting and stopping the engine with its volume raised to the maximum level may harm your hearing.
Be careful about adjusting the volume.

Power on / off

Notes:

- Start the engine before using this unit.
 - Be careful about using this unit for a long time without running the engine. If you drain the car's battery too far, you may not be able to start the engine and this can reduce the service life of the battery.
- Start the engine. The power button / knob illumination on the unit will light up.



- Press the [SRC / ϕ] button on the front panel to turn on the power under standby mode. The unit goes back to the last status after power on.
- Press and hold the [SRC / ϕ] button on the front panel to turn off the power.

CT (Clock Time) display

- The displayed clock data is based on the CT (clock time) data in the RDS signal.

Volume adjustment

Turn the [VOLUME] knob on the front panel. The adjustable range of volume is 0 to 40.

CAUTION

While driving, keep the volume level at which external sounds can still be heard.

Playing source selection

Press [SRC / ϕ] button on the front panel repeatedly to choose desired playing source.

Notes:

- Playing source selection means selecting which mode, such as DISC mode, RADIO mode and AUX mode.

Display system time

Press the [DISP] button on the front panel to switch the display information between RDS information, system time and playing source.

RESET

If you have below problems, pls press [RESET] button.

- Unit can not power on
- Nothing happens when buttons are pressed
- Display is not accurate

Note:

- When the [RESET] button is pressed, preset radio stations, audio setting, etc. stored in memory are kept.

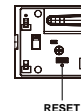

System Setup

In any mode, press and hold [DISP] button to enter system setup. Press [◀▶] buttons to select options, rotate the [VOLUME] knob to adjust.

AF: ON/OFF

Rotate the [VOLUME] knob to choose AF ON or OFF.

REG: ON/OFF

Rotate the [VOLUME] knob to choose REG ON or OFF.

DX/LO (RADIO mode)

Rotate the [VOLUME] knob to choose radio local or distant at RADIO mode.

- **LO:** Only stations with strong signal can be received.
- **DX:** Stations with strong and weak signals can be received.

AUX SENS (AUX mode)

Rotate the [VOLUME] knob to choose AUX Input sensitivity LOW, MID or HIGH at AUX mode.

SCRN SVR: ON/OFF

Rotate the [VOLUME] knob to choose SCR N SVR (screen saver) ON or OFF.

SCROLL: ON/OFF

For track information that is longer than the display panel:

When SCROLL is ON, the LCD will display ID3 TAG information cyclely, e.g: TRACK->FOLDER->FILE->ALBUM->TITLE->ARTIST->TRACK->...

When SCOLL is OFF, the LCD will scroll the ID3 TAG information across the display, the default

is TRACK, but user can adjust it to other ID3 TAG information by press [BAND] button.

REAR/S-W

Rotate the [VOLUME] knob to choose REAR or S-WOOFER (SUB-WOOFER).

TEL-SW

Rotate the [VOLUME] knob to choose MUTE, ON or OFF.

- **MUTE:**
The sound from this unit is muted during telephone calls.
- **OFF:**
This unit continues normal operation even when the cellular phone is used.
- **ON:**
You can listen to your telephone calls from the speakers connected to this unit.
*When listening to your calls on your car speakers, you can adjust the volume by turning the [VOLUME] knob.

BEEP: ON/OFF

Rotate the [VOLUME] knob to choose button beep sound ON or OFF.

RESET (ALL):

1. Select "RESET".
2. Press and hold the [VOLUME] knob to reset.
3. Settings will be set to the default value.
4. The unit will be turned off automatically.

Note:

- When the [RESET] is selected and you press and hold the [VOLUME] knob, radio station frequencies, titles, and other data stored in memory are cleared.

Rotate the [VOLUME] knob to change the CUSTOM setting, and press the [VOLUME] knob,

the press [◀▶] or [▶▶] button to select it including: BAS-G -> BAS-F -> BAS-Q -> MID-G -> MID-F -> MID-Q -> TRE-G ->

Audio Setup

TRE-F, rotate the [VOLUME] knob to select a value.

BAS-G / MID-G / TRE-G: (-7)- (+7)
BAS-F: 60 / 80 / 100 / 200
BAS-Q: 1.0 / 1.25 / 1.5 / 2.0
MID-F: 500 / 1K / 1.5K / 2.5K
MID-Q: 0.5 / 0.75 / 1.00 / 1.25
TRE-F: 10.0K / 12.5K / 15.0K / 17.5K

Press the [♪] button, then press [◀▶▶▶]

buttons to select USER preset including: BALANCE -> FADER -> M-B EX -> LPF(low pass filter) -> S-W VOL (Subwoofer Volume), rotate the [VOLUME] knob to select a value. BALANCE:LEFT 1-7->CENTER->RIGHT 1-7
FADER:FRONT 1-7->CENTER->REAR 1-7
M-BEX: ON/OFF
LPF: THROUGH/80/120/160
SUBW VOL: (-6)-(+6)

Radio Operations

Select tuner as playing source

Press [SRC / ⏸] button once or more to enter RADIO mode.

Select the radio band

Press the [BAND] button on the panel to select one radio band among FM1, FM2, FM3, MW and LW.

Manual tuning

During manual tuning, the frequency will be changed in steps.

Press the [◀▶] / [▶▶] buttons on the panel to select a higher / lower station.

Auto tuning

Press and hold the [◀▶] / [▶▶] buttons on the panel to seek a higher / lower station.

To stop searching, repeat the operation above or press other buttons having radio functions.

Note:

When a station is received, searching stops and the station is played.

Preset scan

Preset scan receives the stations stored in preset memory in order. This function is useful when searching for a desired station in memory.

1. Press the [PS/AS] button.
2. When a desired station is tuned in, press the [PS/AS] button again to continue receiving that station.

Note:

- Be careful not to press and hold the [PS/AS] button for 1 second or longer, otherwise the auto store function will begin and the unit starts storing stations.

Auto store

Only stations with sufficient signal strength will be detected and stored in the memory.

Press and hold the [PS/AS] button (1 sec.) to start automatic station search. To stop auto store, press other buttons having radio functions.

Notes:

1. After auto store, the previously stored stations will be overwritten.
2. The unit has 5 bands, such as FM1, FM2, FM3, MW, LW, FM3 and MW, LW can store by AS function. Each bands can store 6 stations, CZ102E/CZ102ER/ CZ102EG can store 30 stations in total.

Audio Setup

Press the [♪] button to enter sound effect setting mode. First press shows current EQ. Rotate the [VOLUME] knob to change the BEAT EQ in this order: OFF -> B-BOOST -> IMPACT -> EXCITE -> CUSTOM

Rotate the [VOLUME] knob to change the CUSTOM setting, and press the [VOLUME] knob, the press [◀▶] or [▶▶] button to select it including: BAS-G -> BAS-F -> BAS-Q -> MID-G -> MID-F -> MID-Q -> TRE-G ->

Radio Operations

Manual store

When one expected radio station has been detected, press and hold number button 1-6 to store it in the memory.

Recall the stored stations

Press one numeric button among 1 to 6 on the panel to select the corresponding stored station.

Local seeking

When LOCAL seeking is ON, only those radio stations with strong radio signal could be received.

To select LOCAL function, press and hold the [DISP] button on the front panel, then press [▶▶] button repeatedly until LO or DX displays on the screen, and rotate the [VOLUME] knob to select Local or Distant mode.

Note:

The number of radio stations that can be received will decrease after the local seeking mode is ON.

Radio Data System Operations

Radio Data System

This unit has a built-in "Radio Data System" decoder system that supports broadcast stations transmitting "Radio Data System" data. When using the "Radio Data System" function, always set the radio to FM mode.

AF function

The AF function switches to a different frequency on the same network in order to maintain optimum reception.

* The factory default setting is ON.

1. Set to system setup by long pressing [DISP] button.
2. Press the [◀◀] or [▶▶] button to select "AF".
3. Rotate the [VOLUME] knob to select ON or OFF.
 - **AF ON:**
"AF" indicator appears in the display and AF function turns on.
 - **AF OFF:**
"AF" indicator disappears in the display and AF function turns off.

REG (Regional programme) function

When the REG function is ON, the optimum regional station can be received. When this function is OFF, if the regional station area switches as you drive, a regional station for that region is received.

* The factory default setting is ON.

Notes:

- This function is disabled when a national station such as BBC R2 is being received.
 - The REG function ON/OFF setting is valid when the AF function is ON.
1. Set to system setup by long pressing [DISP] button.
 2. Press the [◀◀] or [▶▶] button to select "REG".
 3. Rotate the [VOLUME] knob to select ON or OFF.

Radio Data System Operations

Manually tuning a regional station in the same network

This function is valid when the AF function is ON and the REG function is OFF.

Note:

This function can be used when a regional broadcast of the same network is received.

TA (Traffic Announcement)

In the TA standby mode, when a traffic announcement broadcast starts, the traffic announcement broadcast is received as top priority regardless of the function mode so you can listen to it. Traffic programme (TP) automatic tuning is also available.

- * This function can only be used when "TP" appears in the display. When "TP" appears, this means that the "Radio Data System" broadcast station being received has traffic announcement programmes.

Setting the TA standby mode

If you press the [TA] button, "TA" lights in the display and the unit is set into the TA standby mode until a traffic announcement is broadcast. When a traffic announcement broadcast starts, "TRAF INF" appears in the display. If

you press the [TA] button while a traffic announcement broadcast is being received, the traffic announcement broadcast reception is cancelled and the unit goes off into the TA standby mode.

Cancelling the TA standby mode

As "TA" lights in the display, press the [TA] button. The "TA" in the display goes off and the TA standby mode is cancelled.

PTY (Programme Type)

This function enables you to listen to a broadcast of the selected programme type even if the unit is on a function mode other than radio.

- * Some countries do not yet have PTY broadcast.
- * In the TA standby mode, a TP station has priority over a PTY broadcast station.

Selecting PTY

Press [MENU] button, then rotate the [VOLUME] knob to select PTY type, press the [VOLUME] knob, the unit begins searching.

CD/MP3/WMA Operations

This unit can playback MP3/WMA files

Notes:

- If you play a WMA file with active DRM (Digital Rights Management), there will be no audio.

To disable DRM

(Digital Rights Management)

When using Windows Media Player 9/10/11, click on Tool -> Options -> Copy music tab, then under Copy settings, unclick the Check box for copy protected music. Then, reconstruct files. Personally constructed WMA files are used at your own responsibility.

Precautions when creating MP3/WMA file

Usable sampling rates and bit rates

1. MP3: Sampling rate 8 kHz-48 kHz, BIT rate 8 kbps-320 kbps / VBR
2. WMA: Bit rate 8 kbps-320 kbps

File extensions

1. Always add a file extension ".MP3", ".WMA" to MP3, WMA file by using single byte letters. If you add a file extension other than specified or forget to add the file extension, the file cannot be played.

CD/MP3/WMA Operations

- Files without MP3/WMA data will not play. The files will be played soundlessly if you attempt to play files without MP3/WMA data.
 - * When VBR files are played, the play time display may differ the play location.
 - * When MP3/WMA files are played, a little no sound part is caused between tunes.

Logical format (File system)

- When writing MP3/WMA file on a CD-R disc or CD-RW disc, please select "ISO9660 level 1, 2 or Joliet" or Apple ISO as the writing software format. Normal play may not be possible if the disc is recorded on another format.
- The folder name and file name can be displayed as the title during MP3/WMA play but the title must be within 32 single byte alphabetical letters and numerals (including an extension).
- Do not affix a name to a file inside a folder having the same name.

Folder structure

A disc with a folder having more than 8 hierarchical levels will be impossible.

Number of files or folders

- Up to 999 files can be recognized per folder. Up to 999 files can be played.
- Tracks are played in the order that they were recorded onto a disc. (Tracks may not always be played in the order displayed on the PC.)
- Some noise may occur depending on the type of encoder software used while recording.

Eject function

Just pressing the [] button, ejects the disc.

Notes:

- If you force a CD into before auto reloading, this can damage the CD.
- If a CD (12 cm) is left ejected for 15 seconds, the CD is automatically reloaded (Auto reload).

Listening to a disc already loaded in the unit



Press the [SRC / ] button to select the CD/MP3/WMA mode.

When the unit enters the CD/MP3/WMA mode, play starts automatically.

Loading a CD

Insert a CD into the center of the CD SLOT with label facing up. The CD plays automatically after loading.

Notes:

- Never insert foreign objects into the CD SLOT.
- If the CD is not inserted easily, there may be another CD in the mechanism or the unit may require service.
- Discs without the  or  mark and CD-ROMs cannot be played by this unit.
- Some CD-R/CD-RW discs may not be usable.

Pausing play

- Press the [4] button to pause play. "PAUSE" appears in the display.
- To resume CD play, press the [4] button again.

Displaying CD titles

This unit can display title data for MP3/WMA disc. When SCROLL is OFF, each time you press the [BAND] button to change the title display.

MP3/WMA disc

Track -> Folder -> File title -> Album -> Title -> Artist -> Track ...



Notes:

- If MP3/WMA disc has no ID3 TAG, "NO TITLE" appears in the display.
- Only ASCII characters can be displayed in Tags.



CD/MP3/WMA Operations

Selecting a track

Track-up

- Press the [] button to move ahead to the beginning of the next track.
- Each time you press the [] button, the track advances ahead to the beginning of the next track.
- For MP3/WMA disc, press and hold the [6] button (1 sec.) to move ahead to +10 tracks.

Track-down

- Press the [] button to move back to the beginning of the current track.
- Press the [] button twice to move back to the beginning of the previous track.
- For MP3/WMA disc, press and hold the [5] button (1 sec.) to move back to -10 tracks.

Fast-forward/Fast-reverse

Fast-forward

Press and hold the [] button .



Fast-reverse

Press and hold the [] button .

* For MP3/WMA discs, it takes some time until the start of searching and between tracks. In addition, some error may occur in the play time.

Folder Select

This function allows you to select a folder containing MP3/WMA files and start playing from the first track in the folder.

- Press the [5] or [6] button. Press the [6] button to move the next folder. Press the [5] button to move the previous folder.
- To select a track, press the [] or [] button.

Search Function

- Press the [MENU] button to enter FOLD SCH mode. Press the [VOLUME] button to enter the folder list search mode.
- Turn the [VOLUME] knob to select a folder.
- Press the [VOLUME] button to enter the file

list search mode. And then the track list appears in the display.

- Turn the [VOLUME] knob to select a track.
- Press the [VOLUME] knob to play.
- When play back MP3 / WMA file, this function is performed in the current folder.

Top function

The top function resets the CD player to the first track of the disc. Press and hold the [4] button (1 sec.) to play the first track (track No. 1) on the disc.

* In case of MP3/WMA, the first track of the current folder will be played.

Other various play functions

Scan play

This function allows you to locate and play the first 10 seconds of all the tracks recorded on a disc. Press the [1] button to perform scan play.

Repeat play

This function allows you to play the current track repeatedly or play a track currently being played in the MP3/WMA folder repeatedly.

CD:

- Press the [2] button once or more until "RPT ON" appears on the LCD to perform repeat play.
- Press [2] button repeatedly until "RPT OFF" appears on the LCD to cancel repeat playback.

MP3/WMA:

- Press the [2] button once or more until "TRACK RPT" appears on the display to perform repeat play, and "RPT" segment lights on.
- For MP3/WMA files, press [2] button repeatedly until "FOLDER RPT" appears on the display for folder repeat play.

CD/MP3/WMA Operations

- Press [2] button repeatedly until "RPT OFF" appears on the display to cancel repeat playback, and "RPT" segment goes off.

Random play

This function allows you to play all tracks recorded on a disc in a random order.

Press the [3] button to perform random play.

AUX Operations

Press [SRC / ϕ] button on the panel to select "AUX".

AUX is just for audio content with 3.5mm Jack connector plugged into audio-in socket on the front panel.

AUX Input sensitivity setting

- Press and hold the [DISP] button (1 sec.).
- Turn the [VOLUME] knob to select "AUX SENS".
- If the output level of connected external audio player is "HIGH", rotate [VOLUME] knob and choose "LOW". And if the output level is "LOW", choose "HIGH".

6. TROUBLE SHOOTING

GENERAL

Problem	Cause	Measure
Unit can not power on.	Unit fuse blown.	Replace with new fuse of correct rating.
	Car battery fuse blown.	Replace with new fuse of correct rating.
Unit can not power on. Nothing happens when buttons are pressed. Display is not accurate.	The microprocessor has malfunctioned due to noise, etc.	Turn off the power and remove the DCP. Press the [RESET] button with a thin rod. Note: When the [RESET] button is pressed, turn off the ACC power.*
		* When the [RESET] button is pressed, preset radio stations, titles, etc. stored in memory are kept.
No/low audio output.	Improper audio output connection.	Check wiring and correct.
	Volume set too low.	Increase volume level.
	Speakers damaged.	Replace speakers.
	Heavily biased volume balance.	Adjust the channel balance to center position.
Poor sound quality or distortion.	Speaker wiring is in contact with metal part of car.	Insulate all speaker wiring connections.
	Non-standard disc used.	Use a standard disc.
	Speaker power rating does not match unit.	Replace speakers.
Tel-Mute malfunction.	Wrong connections.	Check wiring and correct.
	Speaker is shorted.	Check wiring and correct.
Unit resets itself when engine is off.	MUTE wire is grounded.	Check the MUTE wiring and correct.
	Incorrect connection between ACC and Battery.	Check wiring and correct.

DISC Player

Problem	Cause	Measure
Disc cannot be loaded.	Another disc is already loaded.	Eject the disc before loading the new one.
	There is an object install inside the unit.	Remove the object inside the unit.
Sound skips or is noisy.	Compact disc is dirty.	Clean the compact disc with a soft cloth.
	Compact disc is heavily scratched or warped.	Replace with a compact disc with no scratches.
Sound is bad when power is first turned on.	Condensation may form on the internal lens when the car is parked in a humid place.	Let dry for about 1 hour with power on.

7. ERROR DISPLAYS

If an error occurs, one of the following displays is displayed. Take the measures described below to solve the problem.

Display	Cause	Measure
ERROR 3	Disc is inserted incorrectly.	Eject the disc then reload it properly.
	The disc format is not supported.	Try another disc.
ERROR 5	This is a failure of deck's mechanism.	Consult your store of purchase.

If an error display other than the ones described above appears, press the [RESET] button. If the problem persists, turn off the power and consult your store of purchase.

- * When the [RESET] button is pressed, preset radio stations, titles, etc. stored in memory are kept.

8. SPECIFICATIONS

FM Tuner

Frequency range: 87.5-108.0MHz
 Usable sensitivity: 8dB
 Frequency response: 30Hz-15kHz
 Stereo separation: 30dB(1kHz)
 Signal/noise ratio: >55dB

MW Tuner

Frequency range: 531-1602kHz
 Usable sensitivity (S/N=20dB): 34dB μ

LW Tuner

Frequency range: 153-279kHz
 Usable sensitivity (S/N=20dB): 34dB μ

CD Player

System: Disc digital audio system
 Frequency response: 20Hz-20kHz
 Signal/noise ratio: >94dB
 Total harmonic distortion: Less than 0.1% (1kHz)
 Channel separation: >60dB

MP3/WMA mode

MP3 sampling rate: 8 kHz to 48 kHz
 MP3 bit rate: 8 kbps to 320 kbps / VBR
 WMA bit rate: 8 kbps to 320 kbps
 Logical format: ISO9660 level 1,2
 Joliet file system

Audio Amplifier

Maximum power output:
 180W (45W x 4)
 Speaker impedance: 4 Ω (4 to 8 Ω allowable)

Input

Audio input sensitivity:
 High: 320mV (at 1V output)
 Mid: 650mV (at 1V output)
 Low: 1.3V (at 1V output)
 (input impedance 10 k Ω or greater)
 Aux-in level: \leq 2V

General

Power supply voltage:
 14.4VDC (10.8 to 15.6V allowable),
 negative ground
 Pre-Amp output voltage:
 2.0V (CD play mode: 1kHz, 0dB, 10k Ω load)
 Fuse: 15A
 Dimensions of the Main Unit:
 188mm Width x 58mm Height x 190mm Depth
 Weight of the Main Unit: 1.30kg

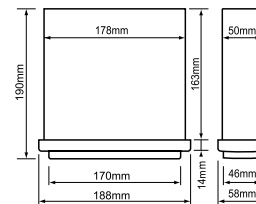
**Note:**

- Specifications and design are subject to change without notice for further improvement.

9. INSTALLATION / WIRE CONNECTION GUIDE

CONTENTS

1) Before Starting	10
2) Package Contents	10
3) General Cautions	10
4) Cautions on Installation	10
5) Installing the Source Unit	10
6) Removing the Source Unit	11
7) Wiring and Connections	12
8) Connecting the Accessories	12

1) Before Starting

1. This set is exclusively for use in cars with a negative ground 12 V power supply.
2. Read these instructions carefully.
3. Be sure to disconnect the battery "terminal" before starting. This is to prevent short circuits during installation. (Figure 1)

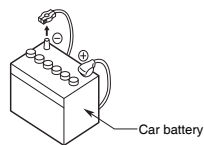

Figure 1

2) Package Contents

Source unit	1	L-key	2
Front panel	1	Wire connector	1
Trim ring	1	DCP case	1
Mounting bracket	1	Owner's manual	1
Special screw (M4x42)	1	Warranty card	1
Screws M5x6 mm	4	Special screw (Front panel lock)	1
Rubber cap	1		

3) General Cautions

1. Do not open the case. There are no user serviceable parts inside. If you drop anything into the unit during installation, consult your dealer or an authorized Clarion service center.
2. Use a soft, dry cloth to clean the case. Never use a rough cloth, thinner, benzine, or alcohol etc. For tough dirt, apply a little cold or warm water to a soft cloth and wipe off the dirt gently.

4) Cautions on Installation

1. Prepare all articles necessary for installing the source unit before starting.
2. Install the unit within 30° of the horizontal plane. (Figure 2)
3. If you have to do any work on the car body, such as drilling holes, consult your car dealer beforehand.
4. Use the enclosed screws for installation. Using other screws can cause damage. (Figure 3)

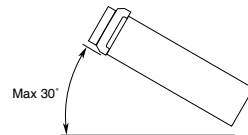

Figure 2

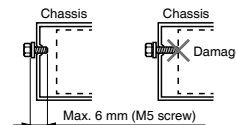

Figure 3

5) Installing the Source Unit

1. Place the mounting bracket into the instrument panel, use a screwdriver to bend each stopper of the mounting bracket inward, then secure the stopper.
2. Wire as shown in Section 7) .
3. Insert the source unit into the mounting bracket until it locks.
4. Take care of the top and bottom of the trim ring and mount it so that all the hooks are locked.

Notes:

1. Some car models require special mounting kits for proper installation. Consult your Clarion dealer for details.
2. Fasten the front stopper securely to prevent the source unit from coming loose.

• Console opening dimensions

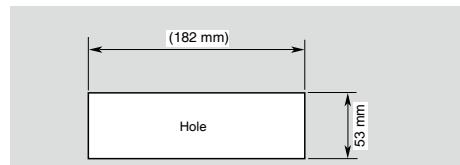

Notes of installation

1. Before installation, please make sure proper connections are conducted and the unit operates normally. Improper connection may result in damage to the unit.
2. Use only accessories designed and manufactured for this unit and other unauthorized accessories may result in damage to the unit.
3. Before installation, please fasten all power cables.
4. DO NOT install the unit in the place where close to hot area to prevent damage to electrical components such as the laser head.
5. Install the unit horizontally. Installing the unit more than 30 degree vertically may result in worse performance.
6. To prevent electric spark, connect the

positive pole first and then the negative pole.

7. DO NOT block the cooling fan exit to ensure sufficient heating dissipation of this unit, or it may result in damage to this unit.

Unit Installation

Method A

1. Insert mounting bracket into dash board, choose appropriate mounting tab according to the gap width, bending the mounting tab outwards with a screwdriver to fix the mounting bracket in place.
2. Screw in 1 piece of M4x42 to the hole of the unit back and put on a rubber cap over the screw. (see picture below)
3. Slide the unit into the bracket until you hear a click sound.

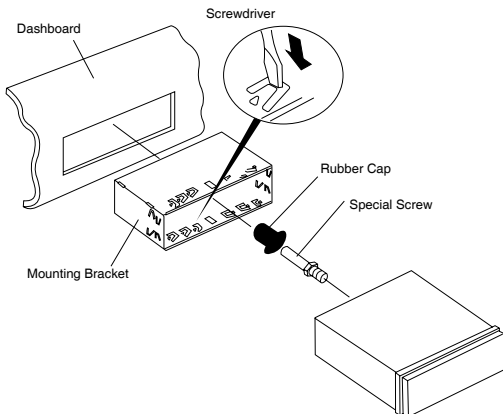

Method B

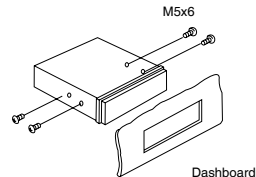
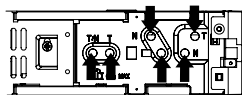

1. Insert this unit directly to the opening of the dashboard.
2. Place M5x6 cylindrical screw through the holes of the mounting frame located inside the opening to holes of the unit and fasten the screws to left & right.

Trim Ring Installation

Attach the trim ring around the front panel. Take care of the top and bottom of the trim ring and mount it so that all the hooks are locked.

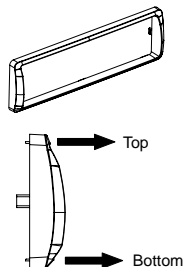

6) Removing the Source Unit

Disassemble trim ring

1. Push the trim ring to right and pull out the right part.

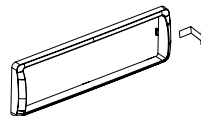

2. Push the trim ring to left and pull out the left part.

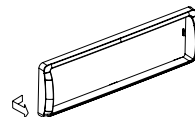

Disassemble the unit

1. Switch off the power.
2. Remove the panel.
3. Remove the trim ring.
4. Insert the removal keys straight back until they lock, then pull the unit out.
5. Disconnect all the wires.

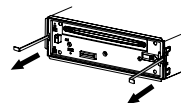

7) Wiring and Connections

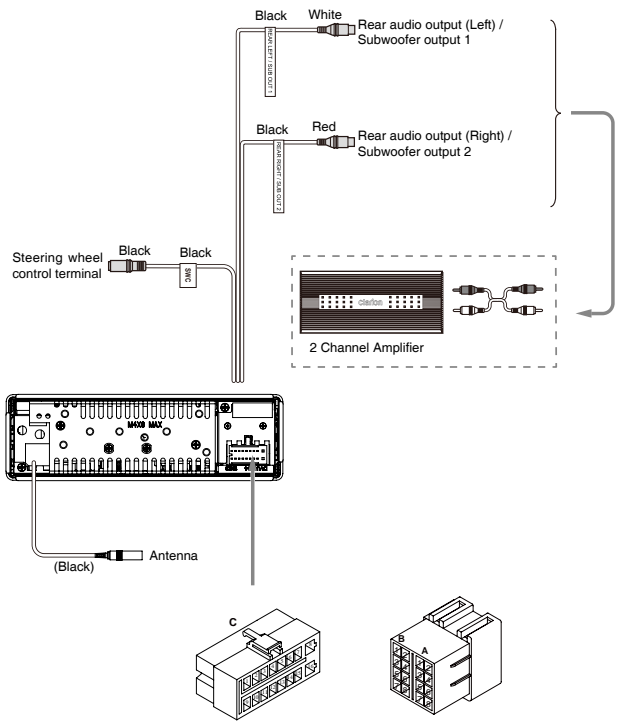

Refer to next page

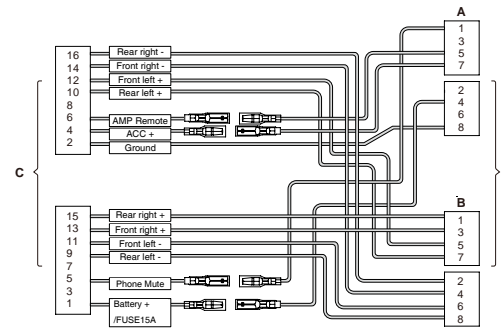

Location	Function	
	Connector A	Connector B
1	Phone Mute / Brown	Rear right (+) / Purple
2		Rear right (-) / Purple with black stripe
3		Front right (+) / Gray
4	Battery 12V(+) / Yellow	Front right (-) / Gray with black stripe
5	Remote On / Blue with white stripe	Front left (+) / White
6		Front left (-) / White with black stripe
7	ACC+ / Red	Rear left (+) / Green
8	Ground / Black	Rear left (-) / Green with black stripe



For VW and Audi: Change wiring like above.

8) Connecting the Accessories

- Connecting to the external amplifier**
 External amplifiers can be connected to the 2 channel RCA output connections. Ensure that the connectors are not grounded or shorted to prevent damage to the unit.



English:

Declaration of conformity

We Clarion declares that this model CZ102E/CZ102ER/CZ102EG is following the provision of Directive 1999/5/EC with the essential requirements and the other relevant regulations.

Français:

Déclaration de conformité

Nous, Clarion, déclarons que ce modèle CZ102E/CZ102ER/CZ102EG est conforme aux exigences essentielles et aux autres dispositions pertinentes de la directive 1999/5/CE.

Deutsch:

Konformitätserklärung

Wir, Clarion, erklären, dass dieses Modell CZ102E/CZ102ER/CZ102EG den Bestimmungen der Richtlinie 1999/5/EG im Hinblick auf die grundlegenden Anforderungen und andere relevante Bestimmungen entspricht.

Italiano:

Dichiarazione di conformità

Clarion dichiara che il presente modello CZ102E/CZ102ER/CZ102EG è conforme ai requisiti essenziali e alle altre disposizioni pertinenti stabiliti dalla direttiva 1999/5/CE.

Nederlands:

Conformiteitsverklaring

Clarion verklaart dat het model CZ102E/CZ102ER/CZ102EG in overeenstemming is met de essentiële eisen en andere relevante voorschriften van de bepalingen van Richtlijn 1999/5/EC.

Español:

Declaración de conformidad

Clarion declara que este modelo CZ102E/CZ102ER/CZ102EG cumple con los requisitos esenciales y otras disposiciones aplicables descritos en la Directiva 1999/5/CE.

Svenska:

Intyg om överensstämmelse

Härmed intygar Clarion att denna modell CZ102E/CZ102ER/CZ102EG uppfyller kraven i direktiv 1999/5/EG gällande väsentliga egenskaper och övriga relevanta bestämmelser.

Polski:

Deklaracja zgodności

Firma Clarion niniejszym oświadcza, że model CZ102E/CZ102ER/CZ102EG jest zgodny z istotnymi wymogami oraz innymi odpowiednimi postanowieniami Dyrektywy 1999/5/WE

Ελληνικά:

Δήλωση συμμόρφωσης

Εμείς στην Clarion δηλώνουμε ότι αυτό το μοντέλο CZ102E/CZ102ER/CZ102EG τηρεί τις διατάξεις της Οδηγίας 1999/5/EK σχετικά με τις ουσιαστικές απαιτήσεις και τους άλλους σχετικούς κανονισμούς.

Clarion Europe S.A.S.

Z.I. du Pré à Varois, Route de Pompey, 54670 Custines, FRANCE

Clarion Co., Ltd.

All Rights Reserved. Copyright © 2011: Clarion Co., Ltd.

Printed in China / Imprimé en Chine / Gedrukt in China

Stampato in Cina / Gedrukt in China / Impresso in China

Trycki i Kina / Wydrukowane w Chinach / Εκτυρωμένο στην Κίνα

PN: 127075003852