

clarion®

Owner's manual

NX502E

**DVD MULTIMEDIA STATION WITH BUILT-IN NAVIGATION & 6.2"
TOUCH PANEL CONTROL**

CAUTIONS:

This appliance contains a laser system and is classified as a "CLASS 1 LASER PRODUCT". To use this model properly, read this Owner's Manual carefully and keep this manual for your future reference. In case of any trouble with this player, please contact your nearest "AUTHORIZED service station". To prevent direct exposure to the laser beam, do not try to open the enclosure.

!CAUTION

USE OF CONTROLS OR ADJUSTMENTS OR PERFORMANCE OF PROCEDURES OTHER THAN THOSE SPECIFIED IN THE OWNER'S MANUAL MAY RESULT IN HAZARDOUS RADIATION EXPOSURE.

ADVARSEL.

Denne mærkning er anbragt udvendigt på apparatet og indikerer, at apparatet arbejder med laserstråler af klasse 1, hvilket betyder, at der anvendes laserstråler af svageste klasse, og at man ikke på apparatets yderside kan blive udsat for utilladelig kraftig stråling.

APPARATET BØR KUN ÅBNES AF FAGFOLK MED SÆRLIGT KENDSKAB TIL APPARATER MED LASERSTRÅLER!
Indvendigt i apparatet er anbragt den her gengivne advarselsmærkning, som advarer imod at foretage sådanne indgreb i apparatet, at man kan komme til at udsætte sig for laserstråling.

OBS!

Apparaten innehåller laserkomponenten som avger laserstråling överstigande gränsen för laserklass 1.

VAROITUS

Suojakoteloja si saa avata. Laite sisältää laseriodin, joka lähettää näkymätöntä silmille vaarallista lasersäteilyä.

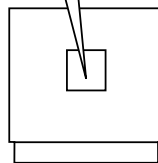

Contents

Thank you for purchasing this **Clarion** product.

- Please fully read this owner's manual before operating this equipment.
- Check the contents of the enclosed warranty card and store it in a safe place with this manual.

| | |
|---|-----------|
| 1. FEATURES | 3 |
| Expanding Systems..... | 3 |
| 2. PRECAUTIONS | 4 |
| 3. CAUTIONS ON HANDLING | 5 |
| Front Panel / Generalities..... | 5 |
| Cleaning the body | 5 |
| USB Port | 5 |
| SD Slot | 5 |
| Handling Discs | 6 |
| 4. CONTROLS | 7 |
| Operational Panel..... | 7 |
| Names of Buttons..... | 7 |
| Remote Control | 8 |
| 5. MAIN MENU OPERATION | 10 |
| 6. SYSTEM SETUP | 11 |
| 7. DISC OPERATION | 14 |
| DVD System..... | 14 |
| Accessing a Disc | 16 |
| DVD Player Operation..... | 17 |
| CD Player Operation | 19 |
| MP3/WMA Playback..... | 20 |
| MP4/DivX Playback..... | 22 |
| 8. SD/USB OPERATION | 23 |
| Accessing an USB..... | 23 |
| Accessing an SD Card | 23 |
| SD/USB Audio Operation..... | 24 |
| SD/USB Video Operation | 24 |
| 9. BLUETOOTH OPERATION | 25 |
| Bluetooth Telephone Operation | 25 |
| Bluetooth Audio Operation | 27 |
| 10. RADIO OPERATION | 28 |
| Radio Data System Operation..... | 30 |
| 11. DAB OPERATION(DAB302E (SOLD SEPARATELY) IS REQUIRED) | 31 |
| 12. iPod & iPhone OPERATION | 33 |
| 13. NAVIGATION OPERATION | 35 |
| 14. AUX OPERATION | 35 |
| 15. TROUBLE SHOOTING | 36 |
| 16. ERROR DISPLAYS | 39 |
| 17. SPECIFICATIONS | 40 |
| 18. WIRING AND CONNECTIONS | 41 |

1. FEATURES

- 6.2" Wide-VGA colour LCD TOUCH PANEL
- Compatible with iPod® / iPhone® via USB
- 4V/6ch RCA Output with HPF/LPF and BEAT-EQ with 3 Band Parametric Equalizer
- Latest Map Guarantee

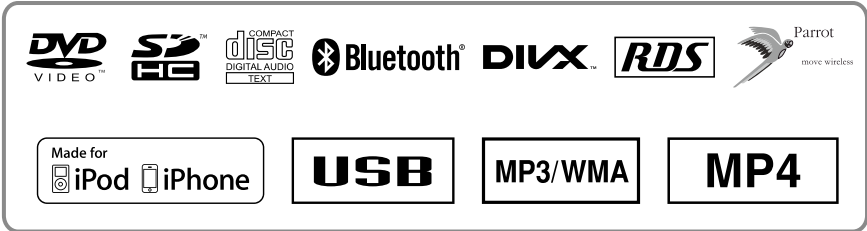

Expanding Systems

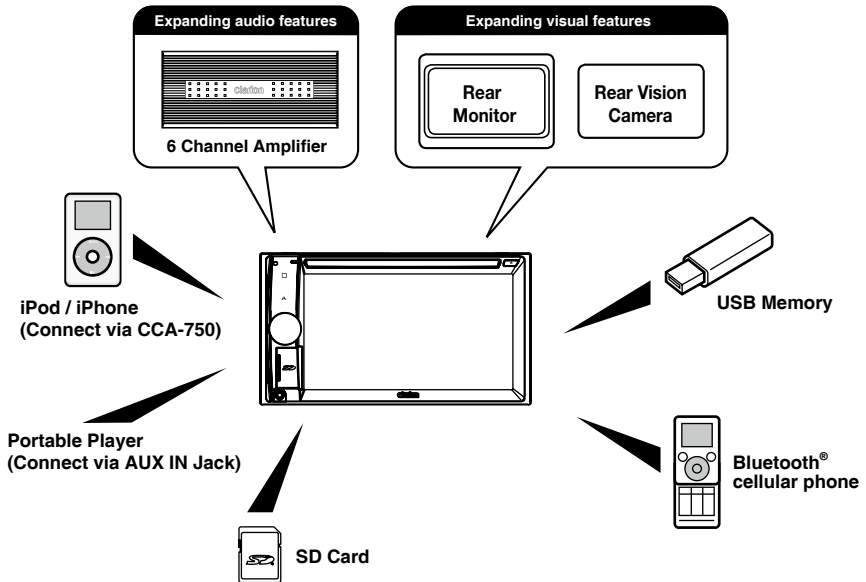

Notes:

- The items listed outside of the frames are the commercial products generally sold.
- CCA-750: Sold by separately.

2. PRECAUTIONS

WARNING

For your safety, the driver should not operate the controls while driving.
Also, while driving, keep the volume to a level at which external sounds can be heard.

1. When the interior of the car is extremely cold and the player is used soon after switching on the heater, moisture may form on the disc or the optical parts of the player and proper playback may not be possible. If moisture forms on the disc, wipe it off with a soft cloth. If moisture forms on the optical parts of the player, do not use the player for about one hour. The condensation will disappear naturally allowing normal operation.
2. Driving on extremely bumpy or rough roads can cause the disc to skip during playback.
3. This unit uses precision parts and components for its operation. In the event that trouble arises, never open the case, disassemble the unit, or lubricate the rotating parts. Contact your Clarion dealer or service center.
4. "Made for iPod," and "Made for iPhone" mean that an electronic accessory has been designed to connect specifically to iPod, or iPhone, respectively, and has been certified by the developer to meet Apple performance standards.
Apple is not responsible for the operation of this device or its compliance with safety and regulatory standards. Please note that the use of this accessory with iPod or iPhone may affect wireless performance.
iPhone and iPod are trademarks of Apple Inc., registered in the U.S. and other countries.
5. 
Manufactured under license from Dolby Laboratories.
"Dolby" and the double-D symbol are trademarks of Dolby Laboratories.
6. This product incorporates copyright protection technology that is protected by U.S. patents and other intellectual property rights. Use of this copyright protection technology must be authorized by Rovi Corporation, and is intended for home and other limited viewing uses only unless otherwise authorized by Rovi Corporation. Reverse engineering or disassembly is prohibited.
Use of this product by the customer is restricted to play program materials to which the Rovi copyright protection process has been applied.
7. The Bluetooth® word mark and logos are registered trademarks owned by Bluetooth SIG, Inc. and any use of such marks by Clarion Co.,Ltd, is under license.
8. DivX®, DivX Certified® and associated logos are trademarks of Rovi Corporation or its subsidiaries and are used under license.
DivX Certified® to play DivX® video, including premium content.
Covered by one or more of the following U.S. patents: 7,295,673; 7,460,668; 7,515,710; 7,519,274
ABOUT DIVX VIDEO: DivX® is a digital video format created by DivX, LLC, a subsidiary of Rovi Corporation. This is an official DivX Certified® device that plays DivX video. Visit divx.com for more information and software tools to convert your files into DivX videos.
ABOUT DIVX VIDEO-ON-DEMAND: This DivX Certified® device must be registered in order to play purchased DivX Video-on-Demand (VOD) movies. To obtain your registration code, locate the DivX VOD section in your device setup menu. Go to vod.divx.com for more information on how to complete your registration.

3. CAUTIONS ON HANDLING

Front Panel / Generalities

For a longer service life, be sure to read the following cautions.

- Do not allow any liquids on the unit from drinks, umbrellas, etc. Doing so may damage the internal circuitry.
- Do not disassemble or modify the unit in any way. Doing so may result in damage.
- Do not let cigarettes burn the display. Doing so may damage or deform the body.
- If a problem should occur, have the unit inspected at your store of purchase.
- The remote control unit may not work if the remote control sensor is exposed to direct sunlight.

Cleaning the body

- Use a soft, dry cloth and gently wipe off any dirt and/or dust.
- For tough dirt, apply some neutral detergent diluted in water to a soft cloth, wipe off the dirt gently, then wipe again with a dry cloth.
- Do not use benzene, thinner, car cleaner, etc., as these substances may damage the body or cause the paint to peel. Also, leaving rubber or plastic products in contact with the body for long periods of time may cause stains.

USB Port

- The USB memory sticks must be recognized as “USB mass storage class” to work properly. Some models may not operate correctly.
When the memorized data is lost or damaged by any chance, Clarion shall not be liable for any damage.
When using an USB memory stick, we recommend that you backup your data stored on it before using a personal computer etc.
- Data files may be broken when using USB memory sticks in the following situation: When disconnecting the USB memory stick or turning the power off during reading data.
When affected static electricity or electric noise.
Connect/disconnect the USB memory stick when it is not accessed.
- Connecting with the computer is not covered.

SD Slot

- When using a SD card, we recommend that you backup your data stored on it before using a personal computer etc.
- Data files may be broken when using SD card in the following situation: When taking off the card or turning the power off during reading data.
When affected static electricity or electric noise.
- Connecting with the computer is not covered.

Handling Discs

Handling

- New discs may have some roughness around the edges. If such discs are used, the player may not work or the sound may skip. Use a ball-point pen or the like to remove any roughness from the edge of the disc.

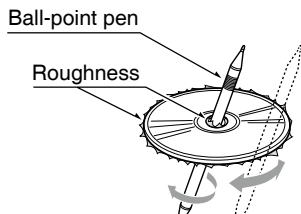

- Never stick labels on the surface of the disc or mark the surface with a pencil or pen.
- Never play a disc with any cellophane tape or other glue on it or with peeling off marks. If you try to play such a disc, you may not be able to get it back out of the player or it may damage the player.
- Do not use discs that have large scratches, are misshapen, cracked, etc. Use of such discs may cause misoperation or damage.
- To remove a disc from its storage case, press down on the center of the case and lift the disc out, holding it carefully by the edges.
- Do not use commercially available disc protection sheets or discs equipped with stabilizers, etc. These may damage the disc or cause breakdown of the internal mechanism.

Storage

- Do not expose discs to direct sunlight or any heat source.
- Do not expose discs to excess humidity or dust.
- Do not expose discs to direct heat from heaters.

Cleaning

- To remove fingermarks and dust, use a soft cloth and wipe in a straight line from the center of the disc to the circumference.
- Do not use any solvents, such as commercially available cleaners, anti-static spray, or thinner to clean discs.
- After using special disc cleaner, let the disc dry off well before playing it.

On Discs

- Never turn off the power and remove the unit from the car with a disc loaded.

CAUTION

For your safety, the driver should not insert or eject a disc while driving.

4. CONTROLS

Operational Panel

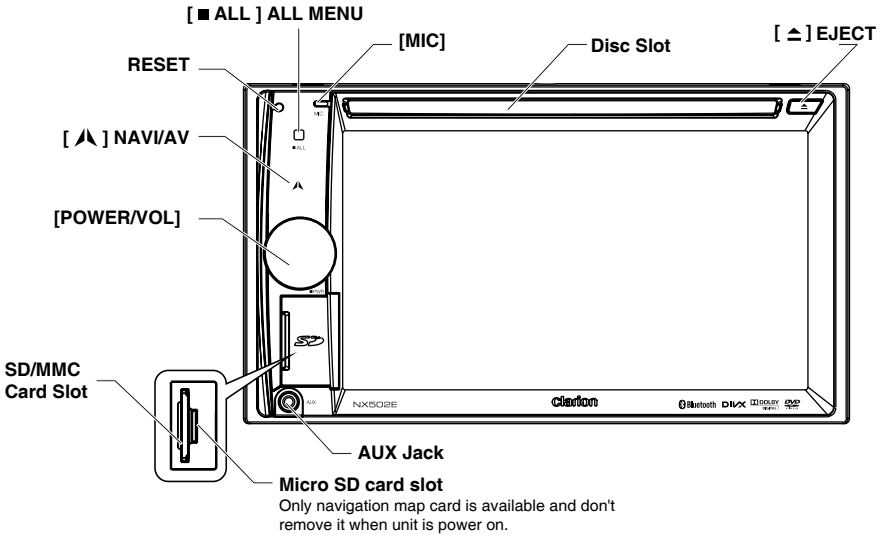

Names of Buttons

[POWER/VOL] Knob

- Press to power on the system when ignition on.
- When power on, short press to mute the volume.
- Rotate the knob to increase or decrease the volume.
- Press and hold this key more than 1 second to turn off the system.

[■ ALL] ALL MENU Button

- Short press to show/exit shortcut menu.
- Long press to show/exit main source menu.

[▲] NAVI/AV Button

- Press to enter navigation mode;
- Press again to return current source.

[▲] EJECT Button

- Press to eject disc.

[MIC] Hole

- Internal microphone

[RESET] Button

- Press to load original settings.

Note: When the [RESET] button is pressed, frequencies of radio stations, titles, etc. stored in memory are cleared.

Remote Control

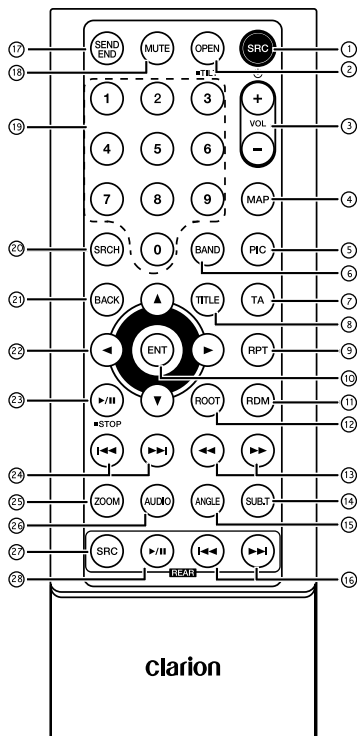

① [SRC / \downarrow] Button

- Show main source menu
- Power on / Power off (long press)

② [OPEN] Button

- Not used

③ [+], [-] Buttons

- Adjust volume level

④ [MAP] Button

- Enter navigation mode

⑤ [PIC] Button

- Adjust screen

⑥ [BAND] Button

- Select tuner band

⑦ [TA] Button

- TA switch

⑧ [TITLE] Button

- DVD TITLE MENU

⑨ [RPT] Button

- Repeat playback

⑩ [ENT] Button

- Enter

⑪ [RDM] Button

- Random playback

⑫ [ROOT] Button

- DVD ROOT MENU

⑬ [◀], [▶] Buttons

- Manual tune
- Fast backward/forward playback

⑭ [SUB.T] Button

- DVD subtitle

⑮ [ANGLE] Button

- DVD angle

⑯ [◀], [▶] Buttons (Rear)

- Chapter up/down
- Fast backward/forward playback (long press)

⑰ [SEND/END] Button

- Pick up
- Hang up

⑱ [MUTE] Button

- Mute the volume

⑲ [0]~[9] Button

- Numeric key

⑳ [SRCH] Button

- DVB-T mode – Number input mode

㉑ [BACK] Button

- DVD mode – Back from source menu return to previous display

㉒ [▲], [▼], [◀], [▶] Buttons

- Move cursor up/down/left/right

Remote Control

23 [▶/II/STOP] Button

- Play/Pause
- Stop (long press)

24 [◀◀], [▶▶] Buttons

- **RADIO** mode
 - Previous / next preset station
 - Seek down/up (long press)
- **DVD** mode
 - Previous/next chapter.
- **CD/BLUETOOTH** mode
 - Previous/next track.

25 [ZOOM] Button

- ZOOM (DVD)

26 [AUDIO] Button

- DVD audio stream change

27 [SRC] Button (Rear)

- Change next rear source

28 [▶/II] Button (Rear)

- Play/Pause
- Stop (long press)

Use and care of the remote control

Using the remote control

Point the remote control in the direction of the front panel to operate.

When using for the first time, pull out the film protruding from the tray.

Replacing the battery

- 1 Slide out the back cover of the remote control.
2. Insert the battery with the plus (+) and minus (-) poles aligned properly.
 - When using for the first time, pull out the film protruding from the tray.
3. Close the back cover.

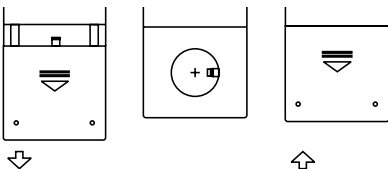

⚠ CAUTION

- Keep the battery out of the reach of children.
- Should the battery be swallowed, consult a doctor immediately.
- Batteries (battery pack or batteries installed) must not be exposed to excessive heat such as sunshine, fire or the like.

⚠ CAUTION

- Use one CR2025 (3 V) lithium battery.
- Remove the battery if the remote control is not used for a month or longer.
- There is a danger of explosion if the battery is incorrectly replaced. Replace only with the same or equivalent type.
- Do not handle the battery with metallic tools.
- Do not store the battery with metallic objects.
- If the battery leaks, wipe the remote control completely clean and install a new battery.
- When disposing of used batteries, comply with governmental regulations or environmental public institutions' rules that apply in your country/area.

► Important

- Do not store the remote control in high temperatures or direct sunlight.
- The remote control may not function properly in direct sunlight.
- Do not let the remote control fall onto the floor, where it may become jammed under the brake or accelerator pedal.

5. MAIN MENU OPERATION

Long press [**ALL**] button on the PANEL to show main source menu.

Short press [**ALL**] button to show Short cut menu.

Front Zone Source

Touch [-] on the bottom of screen to show front zone sources.

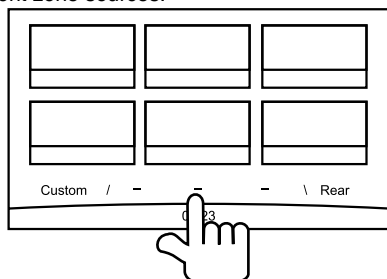

Change page by dragging left or right or touching other two [-] buttons.

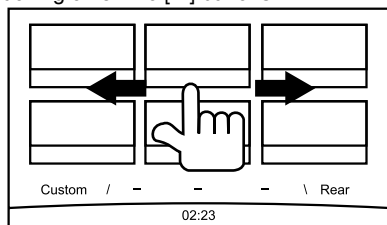

Touch the icons on the screen to enter corresponding work mode, such as Disc mode, Tuner mode, Telephone mode, etc. Touch [**Audio Off**] to mute the volume.

Rear Zone Source

Touch [**Rear**] on the bottom of screen to show rear zone sources.

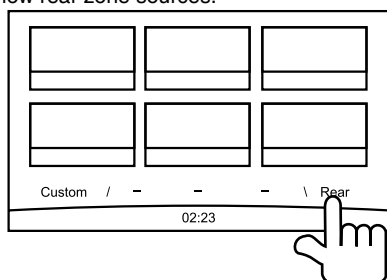

Touch the icons on the screen to enter corresponding work mode, such as Disc mode, USB mode, iPod mode, etc.

Touch [**2ZoneOff**] to turn off the rear zone monitor.

Custom Setting

Touch [**Custom**] on the bottom of screen to show custom setting menu.

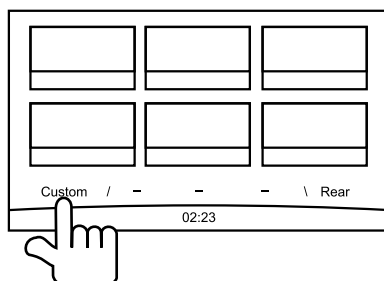

[**Settings**]: Touch the icon to enter system setting menu. (see "System Setup")

[**Beat EQ**]: Touch the icon to enter equalizer setting menu. (see "System Setup")

[**Short Cut**]: Touch the icon to enter Shortcut setting menu. Hold the desired icon for more than 2 seconds until it's activated, then drag it to the bottom. The name will appear on the bottom.

- Hold the center of the screen and drag left or right to show more icons.
- You can make total 5 shortcuts.
- You can access the shortcut list by pressing the [**ALL**] button.

[**Illumi Color**]: Touch the icon to enter Illumination color setting menu. (see "System Setup")

[**Wallpaper**]: Touch the icon to enter Wallpaper setting menu. (see "System Setup")

[**Monitor Off**]: Touch the icon to turn off the monitor.

To turn on the monitor, touch the monitor again.

6. SYSTEM SETUP

At all mode, long press [**ALL**] button to enter main source menu. Touch [**Custom**] on the bottom left of the screen, then select [**Settings**] on the screen to enter Setting menu. Touch the icons on the left of screen to select category: General, Time, Sound, Display or Setup. To exit Setting menu, touch [**BACK**] on the bottom left of the screen.



General

System language

Touch the button to the right of “System language” to show language list. Select desired language, touch [**OK**] to confirm, or touch [**Cancel**] to exit without saving.

Close operation bar

When select [**Auto**], the operation bar will close automatically after 10 seconds.

When select [**Manual**], the operation bar will not close unless you touch the blank area on the screen.

Main Menu Icons

When select [**Active**], main menu show animation icons.

When select [**Simple**], main menu show simple icons.

Illumi Color

Touch [**Set**] to the right of “Illumi Color” to show key illumination setting menu.

Edit Color: There are 12 preset colors and 3 custom colors, you can select one color by touch Color 1~12 or Custom 1~3.

Touch [**Adjust**] to show edit color menu.

Drag the color bar or inputting the RGB value to select one color, touch [**OK**] to confirm.

Initialize: Load original buttons backlight.

Touch [**BACK**] on the bottom left of the screen to return to main setting menu.

Wallpaper

Touch [**Set**] to the right of “Wallpaper” to show Wallpaper setting menu.

Touch [**◀**] or [**▶**] button to select the scene, and touch the picture file name on the right to preview it, then touch [**Set**] to confirm the setting.

To import images, touch [**Import**].

Select a mobile storage device on the list, then select desired images and touch [**Import**]. Touch [**Cancel**] to exit.

Beep

Touch [**On**] or [**Off**] to turn on/off the key beep sound.

Blinking LED

Touch [**On**] or [**Off**] to turn on/off the blinking LED.

At blinking LED [**On**] mode, when ACC off, the LED on the top left of the panel will blink.

Amplifier cancel

Touch [**On**] or [**Off**] to set the internal amplifier on or off.

System software

Touch [**Version**] to show current software version.

Factory default

Touch [**Restore**] to load the original factory settings.

Time

GPS sync

Touch [**On**] to synchronize time with GPS and the following setting is disable: “Time”.

Time

Touch the button to the right of “Time” to show time setting menu. Touch [**▲**] or [**▼**] button to select hour or minute. Touch [**Set**] to confirm or [**Back**] to exit without saving.

24-Hour format

Touch [**On**] to select 24-Hour format.

Touch [**Off**] to select 12-Hour format.

Sound

Beat EQ

Touch the button to the right of "Beat EQ" to show EQ setting menu. You can select : "Bass Boost", "Impact", "Excite", "Custom" or "Off".

To adjust the value, touch [-] or [+] button on the screen.

Touch **[Back]** to exit.

Balance/Fader

Touch **[Set]** to the right of "Balance/Fader" to show Balance/Fader setting menu.

Touch [▲] or [▼] button to adjust Fader, and touch [◀] or [▶] button to adjust Balance.

Touch **[Center]** to reset the value.

Touch **[Back]** to exit.

Sub woofer control

Touch [-] or [+] button on the right of "Sub woofer control" to adjust sub woofer level.

Sub woofer phase

Touch to select sub woofer phase Normal or Reverse.

High pass filter

Touch the button to the right of "High pass filter" to show the sub-menu, then select the filter: "Through", "55Hz", "85Hz" or "120Hz".

Touch **[Cancel]** to exit.

Low pass filter

Touch the button to the right of "Low pass Filter" to show the sub-menu, then select the filter: "Through", "62Hz", "95Hz" or "135Hz".

Touch **[Cancel]** to exit.

Magna Bass Ex

Touch **[On]** to turn on the loudness.

Display

Dimmer Mode

Touch **[Auto]**, **[Day]** or **[Night]** to choose dimmer mode.

Auto: The dimmer is controlled by your car light.

Dimmer

Touch [-] or [+] button to the right of "Dimmer" to adjust dimmer.

The setting is only for Day or Night.

Setup

Touch **[Setup]** on the right of screen to open the setting list. then touch the button to the right of desired option to adjust or show the sub-menu. Touch **[Close]** to close the list.

AUX

- **Input Aux Sense (AUX1)**
Choose "Low", "Middle" or "High" input sense of auxiliary device.

Bluetooth

- **Bluetooth**
Choose Bluetooth function on or off.
- **Telephone Speaker**
Choose Front Left or Front Right speaker at telephone mode.
- **Tone Select**
Touch **[Auto]** to use ringtones of your mobile phone.
Touch **[Internal]** to use preset ringtone of the unit.
- **Software Update**
Update the software.

Camera

- **Camera Interrupt**
Choose **[On]**, the screen will switch to rear camera menu automatically when backing.

DVD

- **Menu Language**
Select menu language from list.
- **Audio Language**
Select audio language from list.
- **Subtitle Language**
Select subtitle language from list.
- **Set Password**
To set password for parental control, Touch **[Set]** to show password menu. Input numbers by touching the digit and

[OK] buttons. Touch [X] button to delete a digit inputted. Touch [Back] to exit.

- **Parental Control**

Touch the button to the right of "Parental Control" to show parental control menu. Enter password, then select a parental level. Touch [OK] to confirm or [Back] to exit.

Navigation

- **Navigation Interrupt**

Select navigation interrupt On, Pop-Up or Off.

- **Voice Guidance**

ON: Interrupt function of voice guidance is on. While interrupting no attenuate function of AV sound.

MUTE: Interrupt function of voice guidance is on. While interrupting attenuate function of AV sound is on.

OFF: Interrupt function of voice guidance is off. While interrupting no attenuate function of AV sound.

Anti Theft

- **Anti Theft code**

You can set an Anti-theft code. After set successfully, when Battery wire reconnect, you need to input the Anti-theft code.

1. Long press the [General] button until a dialog box popped up. Touch [Yes] to set a personal code of Anti-Theft.
2. Input a 4-digit code. Touch [OK] to confirm. Then input it again for confirmation.
3. To remove the code, long press the [General] button and input the old password.

Note:

Please make a note of the Anti theft code not to forget. if the right code is not inputted, it becomes impossible to operate this unit.

7. DISC OPERATION

DVD System

DVD video is a high-quality digital video source that provides crisp and clear images. One 12 cm disc contains either one film or four hours of music.

DVD Video Features

This unit provides the following functions in addition to the high image quality and sound quality of DVD video.

Notes:

- The functions described in this section, for example, the recorded language, subtitles, angles, etc. differ depending on the DVD video disc. Refer to the instructions provided with the DVD video.
- Some disc functions may operate differently from described in this manual.

Multi-sound function

DVD video can store up to 8 languages for one film; select the language of your preference.

- The languages stored on the disc are indicated by the icon shown below.



Multi-angle function

A DVD video that is filmed from multiple angles allows you to select the angle of choice.

- The number of recorded angles are indicated by the icon shown below.



Subpicture (subtitles) function

A DVD video can record subtitles for up to 32 languages and you can select the language of the subtitles you wish to see.

- The number of recorded subtitle languages are indicated by the icon shown below.



Multi-story function

When a DVD video contains more than one story for a film, you can select the story you wish to enjoy.

The operation procedures vary with the disc; observe the instructions for selecting a story provided during playback.

Menu screens

Menu can be called up during DVD video playback to perform menu setting.

- Example showing menu display



Discs

Playable discs

This DVD video player can play the following discs.



About CD Extra discs

A CD Extra disc is a disc in which a total of two sessions have been recorded. The first session is Audio session and the second session is Data session. Your personally-created CDs with more than second data

sessions recorded cannot be played on this DVD video player.

Note:

- When you have a CD Extra disc, only the first session will be recognized.

About playing a CD-R/CD-RW disc (MP3, WMA)

This player can play CD-R/CD-RW discs previously recorded in music CD format (MP3, WMA)

About playing a DVD-R/RW or DVD+R/RW disc

This player cannot play DVD-R/RW and DVD+R/RW discs previously recorded in video CD format.

However, MP3/WMA files recorded on DVD-R/RW and DVD+R/RW discs can be played.

Discs that cannot be played back

This DVD video player cannot play back DVD-Audio, DVD-RAM, Photo CDs, etc.

Note:

- It may also not be possible to play back CDs recorded on a CD-R unit and CD-RW unit. (Cause: disc characteristics, cracks, dust/dirt, dust/dirt on player's lens, etc.)
- If a CD-R or CD-RW disc that has not been finalized is played, it will take a long time to start playing. Also, it may not be possible to play depending on its recording conditions.
- You cannot play SuperAudio CDs Playback of the CD player is not supported even if it is a hybrid disc.

About MP3/WMA playback

This unit can play back CD-R/CD-RW, DVD-R/RW and DVD+R/RW discs on which MP3/WMA music data have been recorded. For a detailed information, see the section entitled "Listening to MP3/WMA".

Note on region numbers

The DVD video system assigns a region number to DVD video players and DVD discs by sales area. DVD video players sold in the Europe can play back DVD discs with the region number "ALL", "2" or any combination

of numbers that also incorporate a "2".

The DVD video region number is marked on the disc jacket as shown below.



Accessing a Disc

CAUTION

For your safety, the driver should not insert or eject a disc while driving.

Eject function

Just pressing the [] button, ejects the disc even if the power to the unit was not turned on.

Notes:

- *If you force a disc into before auto reloading, this can damage the disc.*
- *If a disc (12 cm) is left ejected for 15 seconds, the disc is automatically reloaded (Auto reload).*

Listening to a disc already loaded in the unit

Long press [ ALL] button to enter main source menu, then select [Disc] to enter Disc mode.

If Disc is not on the current source menu, touch [-] buttons on the bottom of the screen, or hold the center of screen and drag left/right to show more icons.

When the unit enters the Disc mode, play starts automatically.

Loading a disc

Insert a disc into the center of the disc slot with label facing up. The disc plays automatically after loading.

Notes:

- *Never insert foreign objects into the disc slot.*
- *If the disc is not inserted easily, there may be another disc in the mechanism or the unit may require service.*

DVD Player Operation

Playback menu

Touch the bottom half of screen to show operation bar.



1. Play/Pause/Stop(long press)
2. Show cursor keys in DVD title menu
3. Previous chapter
Fast-backward (long press)
4. Progress bar
5. Next chapter
Fast-forward (long press)
6. Root menu
Root Title (long press)
7. Show other options

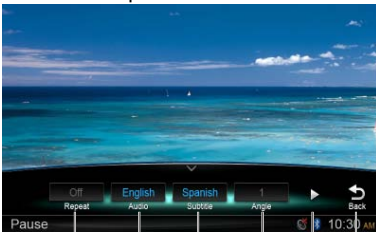

8. Repeat play
9. Select audio language
10. Select subtitle language
11. Show next page
12. Select DVD angle
13. Back to main operation bar



- 14
- 15
- 16
- 17
- 18
- 19
- 13

14. Show previous page
15. Turn on Widescreen mode
16. Direct search
17. Adjust picture effect
18. Show playback information
19. Mute indicator

Pausing play

1. Touch the [||] button on the screen to pause play.
2. Touch [▶] button to resume play.

Selecting a chapter

Chapter-up

Touch the [▶▶] button to move to the beginning of the next chapter.

Chapter-down

Touch the [◀◀] button to move back to the beginning of the current or previous chapter.

Fast forward/Fast reverse

Fast forward

Touch and hold the [▶▶] button for more than 2 seconds.

Fast reverse

Touch and hold the [◀◀] button for more than 2 seconds.

Repeat

During playback, touch [ⓘ], [Repeat] buttons to repeat play.

Search function

During playback, touch [ⓘ], [Q] buttons to show search menu.

Input number by digit buttons, touch [OK] to begin searching or touch [Close] to clear inputting.

Touch [Chapter] or [Title] to show DVD chapter/title list.

DVD audio select

During playback, touch [ⓘ], [Audio] buttons to select audio language to listen if the DVD has multiple audio languages.

DVD subtitle select

During playback, touch [], [**Subtitle**] buttons to select the subtitle language if the DVD has multiple language subtitles.

Playback information

During playback, touch [], [**Information**] buttons to view playback information.

Adjust picture

During playback, touch [], [**Adjust Picture**] button, then use [-], [+] buttons to adjust Dimmer/Brightness/Contrast/Color.

DVD angle select

During playback, touch [], [**Angle**] buttons to select different angle to view if the DVD has multiple-angle views.

CD Player Operation

Playback menu

Touch the bottom half of screen to show operation bar.



1. Show track list (Browse)
2. Title/Artist/Album information
3. Play/Pause
4. Repeat play
5. Previous track
Fast reverse (long press)
6. Progress bar
7. Next track
Fast forward (long press)
8. Random play
9. Show other options
Scan: Scan play stored stations

Browse mode

Touch the [List] button to show track list. Drag up/down to browse the tracks, and touch desired track to select it.

Pausing play

1. Touch the [||] button on the bottom left of the screen to pause play.
"PAUSE" appears in the display, and [||] button becomes [▶].
2. Touch [▶] button to resume play.

Selecting a track

Track-up

1. Touch the [▶▶] button to move to the beginning of the next track.

Track-down

1. Touch the [◀◀] button to move back to the beginning of the current track.

2. Touch the [◀◀] button twice to move back to the beginning of the previous track.

Fast forward/Fast reverse

Fast forward

Touch and hold the [▶▶] button.

Fast reverse

Touch and hold the [◀◀] button.

* For MP3/WMA discs, it takes some time until the start of searching and between tracks. In addition, some error may occur in the play time.

Search Function

1. Touch the [List] button to show track list. Touch [Search] button to enter search menu.
2. Input numbers by touching digit buttons, then touch [Search] to begin searching. To delete numbers, touch [X] button.
3. Touch [●] button to exit.

Other various play functions

Scan play

This function allows you to locate and play the first 10 seconds of all the tracks recorded on a disc.

Touch the [Scan] button, then touch [Scan] to scan play.

Repeat play

This function allows you to play the current track repeatedly or play a track currently being played in the MP3/WMA folder repeatedly.

Touch the [Repeat] button to select Track Repeat, Folder Repeat or All Repeat.

Random play

This function allows you to play all tracks recorded on a disc in a random order.

Touch the [Random] button to perform random play.

MP3/WMA Playback

This unit is an ID3 Tag compatible model. This unit supports the ID3 TAGs of the Version 2.4, 2.3, 1.1 and 1.0. In displaying, this unit gives priority to the Version 2.3 and 2.4 TAGs.

What is MP3/WMA

MP3 is an audio compression method and classified into audio layer 3 of MPEG standards.

WMA is an audio compression method developed by Microsoft Corporation. These audio compression methods have penetrated into PC users and become a standard format.

These features compress the original audio data to about 10 percent of its initial size with a high sound quality. This means that about 10 music CDs can be recorded on a CD-R disc or CD-RW disc to allow a long listening time without having to change CDs.

Note: Some CDs recorded on CD-R/RW mode may not be usable.

Displaying MP3/WMA TAG titles

Tag information such as title, artist and album title can be displayed for MP3/WMA file containing Tag information.

Precautions when creating MP3/WMA file

Usable sampling rates and bit rates

1. MP3: Sampling rate 8 kHz-48 kHz, Bit rate 8 kbps-320 kbps / VBR
2. WMA: Bit rate 8 kbps-320 kbps

File extensions

1. Always add a file extension “.MP3”, “.WMA” to MP3, WMA file by using single byte letters. If you add a file extension other than specified or forget to add the file extension, the file cannot be played.
2. Files without MP3/WMA data will not play. The files will be played soundlessly if you attempt to play files without MP3/WMA data.
 - * When VBR files are played, the play time display may differ the play location.
 - * When MP3/WMA files are played, a little no sound part is caused between tunes.

Logical format (File system)

When writing MP3/WMA file on a CD-R disc or CD-RW disc, please select “ISO9660 level 1, 2 or Joliet or Romeo” or Apple ISO as the writing software format. Normal play may not be possible if the disc is recorded on another format.

Folder structure

A disc with a folder having more than 8 hierarchical levels will be impossible.

Number of files or folders

1. Up to 999 files can be recognized per folder.
 - Up to 6000 files can be played.
2. Tracks are played in the order that they were recorded onto a disc. (Tracks may not always be played in the order displayed on the PC.)
3. Some noise may occur depending on the type of encoder software used while recording.

Playing MP3 folders

When selected for play, files and folders (Folder Search, File Search or Folder Select) are accessing in the order in which they were written to the media.

As a result, the order in which they are expected to be played may not match the order in which they are actually played.

You may be able to set the order in which MP3/WMA files are to be played by assigning file names beginning with play sequence numbers such as “01” to “99”.

For example, a medium with the following folder/file hierarchy is subject to Folder Search, File Search or Folder Select.

See the diagram below.

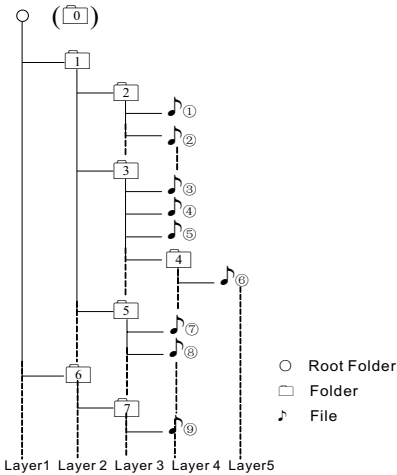

The player will only recognize three folder levels and does not display folders containing other folders. In the example above, the unit will display folders 2, 3, 5 and 7, but 1 and 6 since they do not contain others.

Playback menu

Touch the bottom half of screen to show operation bar.

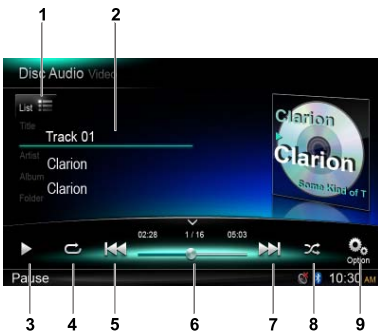

1. Show folder/file list (Browse)
2. Folder/Title/Artist/Album information
3. Play/Pause
4. Repeat play
5. Previous track
Fast reverse (long press)
6. Progress bar
7. Next track
Fast forward (long press)
8. Random play
9. Show other options



10. Scan play
11. Rotate the album image
12. Back to main operation bar

Folder Select

This function allows you to select a folder containing MP3/WMA files and start playing from the first track in the folder.

Touch the [List] button on the upper left of the screen to show folder/file list. You can select a folder or file by touching it.



Search Function

1. Touch the [List] button to show folder/file list. Touch [Search] button to enter search menu.
2. Input numbers by touching digit buttons, then touch [Search] to begin searching.
To delete numbers, touch [X] button.

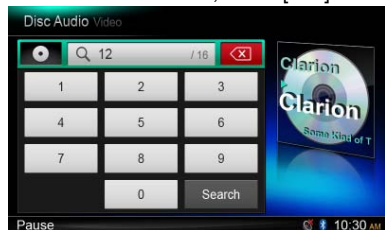

Other operations about playing MP3/WMA are same as CD Player mode.

MP4/DivX Playback

Playback menu

When playing, touch the bottom half of screen to show operation bar.

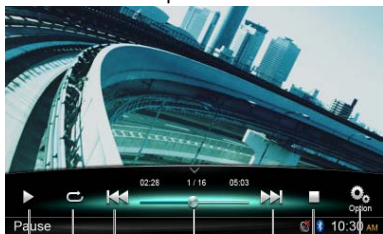

1. Play/Pause
2. Repeat playback
3. Previous file
Fast reverse (long press)
4. Progress bar
5. Next file
Fast forward (long press)
6. Stop and show list menu (Browse)
7. Show other options

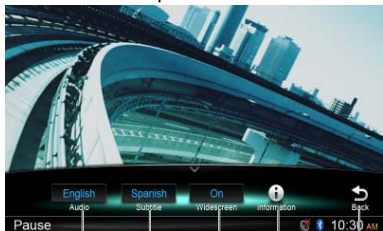

8. Select audio language
9. Select subtitle language
10. Turn on Widescreen mode
11. Show playback information
12. Back to main operation bar

Browse mode

Touch the [■] button to show folder/file list. Drag up/down to browse, and touch desired option to select it.

Pausing play

1. Touch the [⏸] button on the screen to pause play.
"⏸ PAUSE" appears in the display.
2. Touch [▶] button to resume play.

Selecting a file

File-up

Touch the [⏮] button to move to the beginning of the next file.

File-down

Touch the [⏪] button to move back to the beginning of the current or previous file.

Fast forward/Fast reverse

Fast forward

Hold the [⏭] button .

Fast reverse

Hold the [⏮] button .

Repeat play

This function allows you to play the current file repeatedly or play files currently being played in the folder repeatedly.

Touch the [🔄] button to select File Repeat, Folder Repeat, All Repeat or Repeat Off.

Search function

1. At video main menu, touch the [■] button to show folder/file list.
2. Touch [🔍] button to enter search menu.
3. Input numbers by touching digit buttons, then touch [Search] to begin searching.
To delete numbers, touch [⌫] button.

Audio select

Touch the [🔊] button and touch [Audio] button to select audio language to listen if the file has multiple languages.

Subtitle select

Touch the [🔊] button and touch [Subtitle] button to select the subtitle language if the file has multiple language subtitles.

8. SD/USB OPERATION

Accessing an USB

1. Insert an USB device into the USB cable.
When connecting an USB device, the unit will read the files automatically.
2. To remove the USB device, you should first select another source or turn off the power, in order to avoid damaging the USB device. Then take off the USB device.
3. To access an USB device already connected to the unit, long press [**■ ALL**] button to enter main source menu, then select [**USB**] to enter USB mode.
If [**USB**] is not on the current source menu, touch [-] buttons on the bottom of the screen, or hold the center of screen and drag left/right to show more icons.

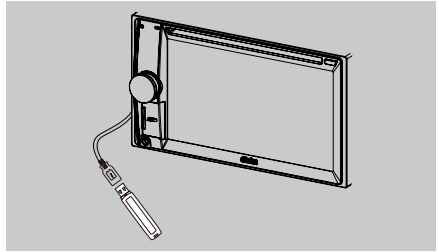

Accessing an SD Card

1. Slide the cover of the card slot located on the bottom left of the panel to the right. Insert an SD card into the card slot.
When inserting a card, the unit will read the files automatically.
2. To remove the card, you should first select another source or turn off the power, in order to avoid damaging the card. Press to pop it out, then take off the card. Close the cover to the left.
3. To access an SD card already inserted in the unit, long press [**■ ALL**] button to enter main source menu, then select [**SD**] to enter SD mode.
If [**SD**] is not on the current source menu, touch [-] buttons on the bottom of the screen, or hold the center of screen and drag left/right to show more icons.

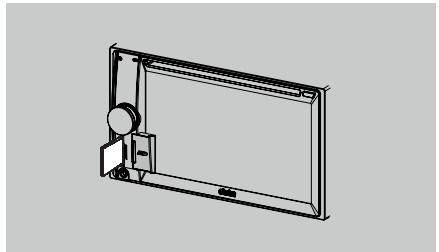

SD/USB Audio Operation

This system can play audio files (MP3/WMA) stored in an SD card or USB memory. You can use it as an audio device by simply copying desired audio files into it.

Notes:

- *This system will not operate or may operate improperly with some card or USB.*
- *Files protected with any DRM cannot be played.*

Select SD/USB Audio mode

Touch top left corner of the screen until SD Audio or USB Audio appears.

Operations about SD/USB audio operations are same as MP3/WMA playback mode.

SD/USB Video Operation

This system can play video files (MP4, etc) stored in an SD card or USB memory. You can use it as a video device by simply copying desired video files into it.

Notes:

- *This system will not operate or may operate improperly with some card or USB.*
- *Files protected with any DRM cannot be played.*
- *Only USB device, DivX is available.*

Operations about SD/USB video are same as MP4/DivX playback mode.

9. BLUETOOTH OPERATION

The Bluetooth allows you to utilize your car's built-in audio system for wireless mobile phone or music handsfree communication. Some Bluetooth mobile phones have the audio features, and some portable audio players support Bluetooth feature. This system can play audio data stored in a Bluetooth audio device. The car stereo with Bluetooth will be able to retrieve phonebook contacts, received call, dialled call, missed call, incoming calls, outgoing call and listen to music.

Notes:

- Do not set the microphone of Bluetooth handsfree in the places with wind passing such as air outlet of the air conditioner, etc. This may cause a malfunction.
- If set it in the places subjected to direct sun, high temperature can cause distortion, discoloration which may result in a malfunction.
- This system will not operate or may operate improperly with some Bluetooth audio players.
- **Clarion** cannot guarantee the compatibility of all mobile phones together with the unit.
- Audio playback will be set to the same volume level as set during telephone call. This might cause problems, if extreme volume level is set during telephone call.

Bluetooth Telephone Operation

Pairing

1. Turn on the Bluetooth function of the unit. (see <System Setup>, <Bluetooth>)
2. Turn on Bluetooth function of your mobile phone.
3. Enter mobile phone's Bluetooth setup menu.
4. Search for new Bluetooth devices.
5. Select **NX502E** from the pairing list on the mobile phone.
6. Enter "0000" as the password.
7. After pairing successfully,  indicator on the bottom right of the screen turns blue.

Search from the unit

You can search Bluetooth device from the unit.

1. Touch [**Add**] on the right of the screen, the unit will search the Bluetooth devices and list on the screen.
2. If your desired device isn't on the list, touch the button on the bottom left of the screen to refresh.
To stop searching, touch [**Cancel**].
3. Touch the device name on the screen to select it, then input PIN code on the sub-menu.
4. After paired successfully, select device image, touch [**OK**] to confirm.

5. If connect unsuccessfully, select [**Retry**] to reconnect or select [**Cancel**] to return to list menu.

Choose paired device

After paired, the mobile device information appears on the right of screen, such as model number, Signal, Battery.

1. To select other paired device, hold the middle right of the screen, and drag it left or right, touch it to show control buttons.
2. Touch [**Connect**] to connect the Bluetooth device. Touch [**Cut**] to disconnect.
3. Touch [] to delete the paired device from pairing list.

Telephone menu

Long press [ **ALL**] button to enter main source menu, then select [**Telephone**] to enter telephone mode.

If [**Telephone**] is not on the current source menu, touch [-] buttons on the bottom of the screen, or hold the center of screen and drag left/right to show more icons.



1. Show history categories
2. Backspace
3. Paired device information
4. Number pad
5. Call/Hang up



6. Turn on/off Auto Connect function
7. Turn on/off Auto Answer function
8. Set PIN code
9. Select internal or external microphone
10. Show next page
11. Back to main operation bar



12. Show previous page
13. Adjust microphone gain
14. Show Bluetooth information
15. Bluetooth indicator

Making a call

• Dial Number

1. Input numbers by digit-keys on the screen.
2. Touch [] button to dial.
Touch [] button to delete characters.
3. Touch [] button to terminate call.

• Dialed/Received/Missed Call History

You can search any Dialed/Missed/Received Call History.



1. Touch [] button to show following history categories: Dialed, Received, Missed and Contacts.
Touch [**Dialer**] to dial number manually.
2. Touch to select a category, the numbers of the category are displayed.
3. Select a number, touch [] button to dial.
Touch [] to return previous menu.

• Call from Phonebook

You can search the contact name in the phonebook and make call.

1. Touch [] button and select [**Contacts**].
It may take a few minutes to synchronize the phone book at first time.
2. Select a number, touch [] button to dial.
Touch [] to return previous menu.

Note:

Some cellular phones may not be able to transfer the Phone Book data.

• Answering a call

You can answer an incoming call by pressing the [] button.

- * Touch [] button to reject an incoming call.

Bluetooth Audio Operation

Audio Streaming Operation

What is audio streaming?

Audio streaming is a technique for transferring audio data such that it can be processed as a steady and continuous stream. Users can stream music from their external audio player to their car stereo wirelessly and listen to the tracks through the car's speakers. Please consult your nearest **Clarion** dealer for more information on the product of wireless audio streaming transmitter offered.

⚠ CAUTION

Please avoid operating your connected mobile phone while audio streaming as this may cause noise or sound choppy on the song playback.

Audio streaming may or may not resume after telephone interrupt as this is dependent on mobile phone.

Note:

Be sure to read the chapter "Pairing" and "Choose paired device" before proceeding.

Playback menu

Touch the bottom half of screen to show operation bar.



1. Title/Artist/Album information
2. Play/Pause
3. Previous track
Fast reverse (long press)
4. Stop
5. Next track
Fast forward (long press)

Play / Pause a track

1. Touch the [||] button to pause audio playback.
2. To resume audio playback, touch the [▶] button.

Selecting a track

Track-up

1. Touch the [►►] button to move to the beginning of the next track.
2. Each time you touch the [►►] button, the track advances to the beginning of the next track.

Track-down

1. Touch the [◀◀] button to move back to the beginning of the current track.
2. Touch the [◀◀] button twice to move back to the beginning of the previous track.

Stop playback

Touch [■] button to stop playback.

Note:

Playing order will depend on Bluetooth audio player. When [◀◀] button is pressed, some A2DP devices will restart the current track depends on the duration of playback.

Some Bluetooth audio players may not have play/pause synchronized with this unit. Please make sure both device and main unit are in the same play/pause status in Bluetooth Audio mode.

10. RADIO OPERATION

Select tuner for listening to the radio

Long press [**ALL**] button to enter main source menu, then select [**Tuner**] to enter **Tuner** mode.

If Tuner is not on the current source menu, touch [-] buttons on the bottom of the screen, or hold the center of screen and drag left/right to show more icons.

Menu of listening to the radio

Touch the bottom half of screen to show operation bar.



1. Band switch
 2. Information area
 3. Preset station number
 4. Current station frequency
 5. Show preset stations list
 6. Scan preset stations
 7. Manual tune backward
Auto tune backward. (long press)
 8. Frequency bar
 9. Manual tune forward
Auto tune forward. (long press)
 10. Show other options
-
11. Choose local or distant seeking mode
 12. Turn on/off Traffic Announcement
 13. Turn on/off Alternative Frequency
 14. Turn on/off Regional
 15. Show next page

16. Back to main operation bar



17. Show previous page
18. Select Programme Type
19. Auto store preset stations

Select one radio band

Touch the top left corner of the screen to select one radio band among FM1, FM2, FM3 and AM.

Manual tuning

During manual tuning, the frequency will be changed in steps.

Touch the [**◀◀**] or [**▶▶**] button on the operation bar to tune in a higher / lower station.

Auto tuning

Hold the [**◀◀**] or [**▶▶**] button on the operation bar for more than 2 seconds to seek a higher / lower station.

To stop searching, repeat the operation above or press other buttons having radio functions.

Note:

When a station is received, searching stops and the station is played.

Preset scan



Preset scan receives the stations stored in preset memory in order. This function is useful when searching for a desired station in memory.

1. Touch the [**🔍**] button on the operation bar.
2. When a desired station is tuned in, press the [**🔍**] button to continue receiving that station.

Auto store

Only stations with sufficient signal strength will be detected and stored in the memory.

To start automatic station search, touch following buttons on the operation bar in

sequence: [] -> [] -> [OK]

To stop auto store, press other buttons having radio functions.

Notes:

1. After auto store, the previous stored stations will be overwritten.
2. The unit has 4 bands, such as FM1, FM2, FM3 and AM. FM3 and AM can store by AS function. Each band can store 6 stations, NX502E can store 24 stations in total.

Manual store

When one expected radio station has been detected, touch [<<<] button on the right edge of the screen to show the preset station list, hold one of the six preset stations for more than 2 seconds to store it in the memory. Touch [>>>] button near the center of screen to hide the preset station list.

Recall the stored stations

Touch [<<<] button on the right edge of the screen to show the preset station list, touch to select a preset station.

Touch [>>>] button near the center of screen to hide the preset station list.

Local seeking

When LOCAL seeking is on, only those radio stations with strong radio signal could be received.

To open LOCAL function, touch [] button on the operation bar, then touch the [Mode] button to select "Local" or "DX".

Note:

The number of radio stations that can be received will decrease after the local seeking mode is on.

Radio Data System Operation

Radio Data System

This unit has a built-in "Radio Data System" decoder system that supports broadcast stations transmitting "Radio Data System" data.

When using the "Radio Data System" function, always set the radio to FM mode.

AF function

The AF function switches to a different frequency on the same network in order to maintain optimum reception.

To turn on or off AF function, touch [] button on the operation bar, then touch the [AF] button to select "On" or "Off"

- **AF ON:**

"AF" indicator lights up and AF function turns on.

- **AF OFF:**

"AF" indicator turns gray and AF function turns off.

REG (Regional programme) function

When the REG function is ON, the optimum regional station can be received. When this function is OFF, if the regional station area switches as you drive, a regional station for that region is received.

To turn on or off REG function, touch [] button on the operation bar, then touch the [REG] button to select "On" or "Off"

- **REG ON:**

"REG" indicator lights/blinks up and REG function turns on.

- **REG OFF:**

"REG" indicator turns gray and REG function turns off.

Notes:

- This function is disabled when a national station such as BBC R2 is being received.
- The REG function ON/OFF setting is valid when the AF function is ON.

TA (Traffic Announcement)

In the TA standby mode, when a traffic announcement broadcast starts, the traffic announcement broadcast is received as top priority regardless of the function mode so you can listen to it. Traffic programme (TP) automatic tuning is also available.

* This function can only be used when "TP" appears in the display. When "TP" appears, this means that the "Radio Data System" broadcast station being received has traffic announcement programmes.

To turn on or off TA function, touch [] button on the operation bar, then touch the [TA] button to select "On" or "Off"

- **TA ON:**

"TA" indicator lights up and the unit is set into the TA standby mode until a traffic announcement is broadcast.

- **TA OFF:**



"TA" indicator turns gray and the TA standby mode is cancelled.

PTY (Programme Type)

This function enables you to listen to a broadcast of the selected programme type.

Selecting PTY

To select PTY type, touch following buttons on the operation bar in sequence:

[] -> [] -> [PTY Select]

Then select desired type on the dialog box, touch [Seek] to begin searching.

11. DAB OPERATION

(DAB302E (SOLD SEPARATELY) IS REQUIRED)

This function is available when DAB302E (sold separately) is connected.

Select DAB as playing source

Long press [**ALL**] button to enter main source menu, then select [**DAB**] to enter **DAB** mode.

If DAB is not on the current source menu, touch [-] buttons on the bottom of the screen, or hold the center of screen and drag left/right to show more icons.

Playback menu

Touch the bottom half of screen to show operation bar.

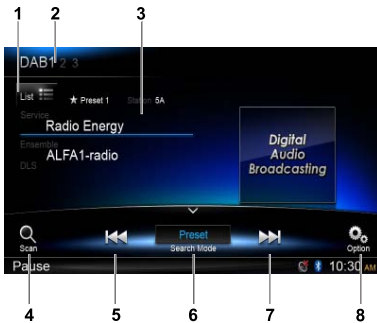

1. Show service list
2. Band switch
3. Information area
4. Scan preset stations
5. Manual tune backward
Auto tune backward (long press)
6. Search Mode
7. Manual tune forward
Auto tune forward (long press)
8. Show other options



9. Turn on/off Service Link.
10. Turn on/off traffic announcement.

11. Search service by Programme Type
12. Search all service available
13. Show next page
14. Back to main operation bar



15. Show previous page
16. Turn on/off L Band
17. Auto store preset stations

Select one DAB band

Touch the top left corner of the screen to select one radio band among DAB1, DAB2 and DAB3.

Tune

There are four search mode. You can select search mode from followings,



- 1. Preset Search**
Search preset service one by one
- 2. Current Search**
Service Search in the current Ensemble
- 3. ALL Search**
Service Search for all stored by Station search
- 4. Manual Search**
During manual tuning, the frequency will be changed in steps.
Touch the [**◀**] or [**▶**] button on the operation bar to tune in a higher / lower station.
Hold the [**◀**] or [**▶**] button on the operation bar for more than 2 seconds to seek a higher / lower station.
To stop searching, repeat the operation above or press other buttons having radio functions.

Note:



When a station is received, searching stops and the station is played.

Preset scan

Preset scan receives the stations stored in preset memory in order. This function is useful when searching for a desired station in memory.

1. Touch the [] button on the operation bar.
2. When a desired station is tuned in, press the [] button to continue receiving that station.

Auto store



Only stations with sufficient signal strength will be detected and stored in the memory. To start automatic station search, touch following buttons on the operation bar in sequence: [] -> [] -> [**Auto Store**] -> [**OK**] .

To stop auto store, press other buttons having radio functions.



Notes:

1. After auto store, the previous stored stations will be overwritten.
2. The unit has 3 bands, such as DAB1, DAB2 and DAB3.

Manual store

1. Touch the [] button to show list menu.
2. Touch the [] button to enter store preset service menu.
3. Select a position to store current service.
4. Touch [] to exit.

Delete stored services

1. Touch the [] button to show list menu.
2. Touch [] to enter the delete menu.
3. Select services and touch [**OK**] to delete.

Recall the stored services



1. Touch the [] button to show list menu.
2. Touch to select a preset service.

PTY Search

Touch [] button on the operation bar, and then touch [**PTY Select**] to show PTY type. Drag up/down to scroll, and touch to select. Touch [**Seek**] to seek a channel within the selected category.



L-BAND ON/OFF

To turn on L-BAND function, touch following buttons on the operation bar in sequence: [] -> [] -> [**L Band**] -> [**OK**] .

Service Link

To select Service Link mode, touch [] button on the operation bar, then touch [**Service Link**] to choose “DAB-DAB”, “DAB-RDS” or “Off”.

12. iPod & iPhone OPERATION

Connect an iPod or iPhone to the USB connector via CCA-750 cable.

When connecting a device, the unit will read the files automatically. The track information display on the screen once playback start.

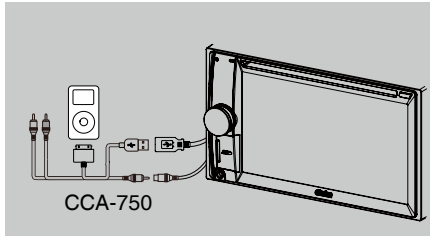

11. Turn on / off Simple Control
12. Select Audiobook play speed
13. Back to main operation bar

Accessing iPod mode

Long press [**ALL**] button to enter main source menu, then select [**iPod**] to enter iPod mode.

If [**iPod**] is not on the current source menu, touch [-] buttons on the bottom of the screen, or hold the center of screen and drag left/right to show more icons.

At iPod Audio mode, touch the bottom half of screen to show operation bar.



1. Show file list (Browse)
2. Switch between iPod Audio and Video
3. Song/Artist/Album information
4. Play/Pause
5. Repeat play
6. Previous track
Fast reverse (long press)
7. Progress bar
8. Next track
Fast forward (long press)
9. Random play
10. Show other options

Browse mode

1. Touch the [**List**] button to show file list.
Drag up/down to browse. Touch a item of list on the screen to select it.
2. Touch [**Play**], [**Next**] and [**Previous**] buttons to show the following categories: Playlists, Songs, Artists, Albums, Genres, Composers, Audiobooks, Podcasts.
3. Touch to select a category, the contents of the category are displayed. Drag up/down to browse.
4. Touch an option to select it.

Pausing play

1. Touch the [**Pause**] button on the bottom left of the screen to pause play.
"PAUSE" appears in the display, and [**Pause**] button becomes [**Play**].
2. Touch [**Play**] button to resume play.

Selecting a track

Track-up

1. Touch the [**Next**] button to move to the beginning of the next track.
2. Each time you touch the [**Next**] button, the track advances to the beginning of the next track.

Track-down

1. Touch the [**Previous**] button to move back to the beginning of the current track.
2. Touch the [**Previous**] button twice to move back to the beginning of the previous track.

Fast forward/Fast reverse

Fast forward

Touch and hold the [▶▶] button .

Fast reverse

Touch and hold the [◀◀] button .

Repeat play

This function allows you to play the track repeatedly.

Touch the [↺] button to select Repeat one or Repeat all.

Random play

This function allows you to play all tracks in a random order.

Touch the [⌘] button to perform random play.

iPod menu alphabet search

This function searches the subfolders for desired alphabetical letters.

1. Touch the [List] button to show file list.

Touch [Q] button to enter search menu.

2. Input characters by touching buttons on the screen, then touch [Search] to begin searching.

Touch [123] to show digit keypad, touch [ABC] to show letter keypad.

Touch [Space] to input a blank space.

Touch [⌫] button to delete characters.

Setting iPod simple control mode

Use this function if you wish to operate through your iPod connected to this unit via the USB cable.

Touch the [Option] button, then touch [Simple Control] to set it to [On].

iPod video playback

To playback video from iPod, touch top left corner of the screen, then select a video file to play.

During playback, touch the bottom half of screen to show operation bar.

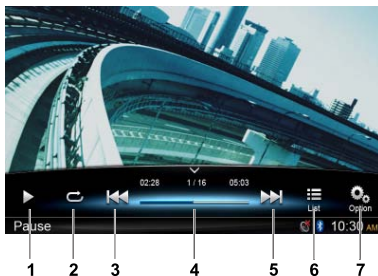

1. Play/Pause
2. Repeat play
3. Previous file
Fast reverse (long press)
4. Progress bar
5. Next file
Fast forward (long press)
6. Show iPod list menu
7. Show other options

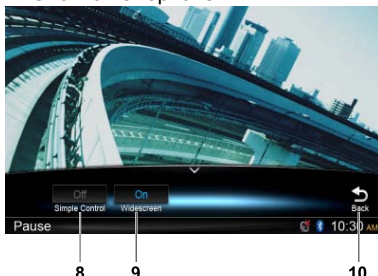

8. Turn on / off Simple Control
9. Turn on Widescreen mode
10. Back to main operation bar

Return to video list menu

Touch [List] button on the operation bar to return to video list menu.

Play videos in wide screen

To play videos in wide screen, touch the [Option] button, then touch [Wide screen] to set it to [On].

13. NAVIGATION OPERATION

Access navigation mode

- Slide the cover of the card slot located on the bottom left of the panel to the right. Insert a map card into the mini card slot.
 - To remove the card, you should first select another source or turn off the power, in order to avoid damaging the card. Press to pop it out, then take off the card. Close the cover to the left.
 - Press [▲] button on panel to visit Navigation mode.
- * The navigation operations depend on your map, it may be different from the following content.

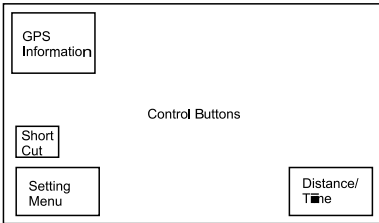

Control buttons

- Touch top left corner of the screen to show GPS informations. Touch **[Back]** to return.
- Touch bottom left corner of the screen to enter Navigation menu. Touch **[Show Map]** to return.
- Touch middle left of the screen to show shortcuts of general functions. Touch [<] button to hide.
- Touch bottom right corner of the screen to show Distance/Time Left/Arrival Time. Touch it again to hide.
- Touch the blank area to show control buttons.

Top left corner: Plane/three-dimensional

Top right corner: Cursor location.

[←]/[→]: Move left/right

[↑]/[↓]: Move up/down

[+]/[-]: Enlarge/reduce the map

[Back]: Hide the buttons.

[More]: Show more informations.

[Select]: Select the route.

14. AUX OPERATION

Long press [■ ALL] button to enter main source menu, then select **[AUX 1]** to visit front auxiliary device, and touch **[AUX 2]** to enter rear auxiliary device.

If **[AUX 1]** or **[AUX 2]** is not on the current source menu, touch [-] on the bottom of the screen, then hold the center of screen and drag left/right to show more icons.

15. TROUBLE SHOOTING

GENERAL

| Problem | Cause | Measure |
|---|---|---|
| Unit can not power on. | Unit fuse blown. | Replace with new fuse of correct rating. |
| | Car battery fuse blown. | Replace with new fuse of correct rating. |
| Unit can not power on. Nothing happens when buttons are pressed. Display is not accurate. | The microprocessor has malfunctioned due to noise, etc. | Turn off the power and press the [RESET] button with a thin rod. Note: <i>When the [RESET] button is pressed, turn off the power.*</i> <i>* When the [RESET] button is pressed, frequencies of radio stations, titles, etc. stored in memory are cleared.</i> |
| Remote control does not work. | | Battery depleted. |
| No/low audio output | Battery installed incorrectly. | Install the battery correctly. |
| | Improper audio output connection. | Check wiring and correct. |
| | Volume set too low. | Increase volume level. |
| | Speakers damaged. | Replace speakers. |
| | Heavily biased volume balance. | Adjust the channel balance to center position. |
| Poor sound quality or distortion | Speaker wiring is in contact with metal part of car. | Insulate all speaker wiring connections. |
| | Non-standard disc used. | Use a standard disc. |
| | Speaker power rating does not match unit. | Replace speakers. |
| | Wrong connections. | Check wiring and correct. |
| Unit resets itself when engine is off. | Speaker is shorted. | Check wiring and correct. |
| | Incorrect connection between ACC and Battery. | Check wiring and correct. |
| The display is dark. | The brightness control is too low. | Adjust the brightness properly. |
| | The operating condition is not good. | The temperature inside the vehicle may be 0°C or lower. Set to an appropriate temperature (25°C or so) and check it again. |
| | The headlight of the vehicle is lit. | The display is made dark at night to prevent the glare (When the headlight of the vehicle is lit in the daytime, the display gets dark.) |
| There are red, green, and blue points in display | | This is not a failure, but a phenomenon peculiar to a liquid crystal panel (The liquid crystal panel is produced according to technology with very high precision. Note that, though there are effective pixels of 99.99% or more, pixel missing or normally lit pixels account for 0.01%). |

DISC Player

| Problem | Cause | Measure |
|---|---|--|
| Disc cannot be loaded. | Another disc is already loaded. | Eject the disc before loading the new one. |
| | There is an object installed inside the unit. | Remove the object inside the unit. |
| Sound skips or is noisy. | Disc is dirty. | Clean the compact disc with a soft cloth. |
| | Disc is heavily scratched or warped. | Replace with a compact disc with no scratches. |
| Sound is bad when power is first turned on. | Condensation may form on the internal lens when the car is parked in a humid place. | Let dry for about 1 hour with power on. |
| Video images are not displayed. | The parking brake is not engaged. | Check that the parking brake is engaged. |
| Disc cannot play with the display "PARENTAL VIOLATION" shown. | Feature exceeds set parental level. | Release the view limitation or change the parental level. See the subsection "Setting up the parental level." |

SD/USB Devices

| Problem | Cause | Measure |
|--|---|--|
| SD card or USB device cannot be inserted. | The SD card or USB device has been inserted with wrong direction. | Reversing the connection direction of the SD card or USB device, try it again. |
| | The SD card or USB connector is broken. | Replace with a new card or USB device. |
| SD card or USB device is not recognized. | The SD card or USB device is damaged. | Disconnect the card or USB device and reconnect. If still not recognized, try replacing with a different card or USB device. |
| | Connectors are loose. | |
| Sound skips or is noisy. | MP3/WMA files are not encoded properly. | Use MP3/WMA files encoded properly. |
| No sound heard with the display "NO FILE" shown. | No MP3/WMA file is stored in the card or USB device. | Store these files properly in the card or USB device. |
| The video image of iPod/iPhone is disturbed. | The TV Signal setting of the iPod/iPhone is not set correctly. | Set the TV Signal setting (NTSC/PAL) of the iPod/iPhone correctly. |

Bluetooth

| Problem | Cause | Measure |
|---|---|--|
| Cannot pair the Bluetooth enabled device with the car audio system. | The device does not support the profiles required for the system. | Use another device to connect. |
| | The Bluetooth function of the device is not enabled. | Refer to the user manual of the device for how to enable the function. |
| The audio quality is poor after connection with a Bluetooth-enabled device. | The internal microphone gain is not set correctly. | Adjust the gain of the internal microphone in System Setup. |
| | The external microphone is not set correctly nor properly positioned. | Adjust the gain and position of the external microphone. For example, stick the microphone onto the dashboard so it is close to the driver. |

16. ERROR DISPLAYS

If an error occurs, one of the following displays is displayed.
Take the measures described below to solve the problem.

| Display | Cause | Measure |
|------------------|--|---|
| Disc loading | Disc is being read | Please wait, it may take several minutes for some disc or storage device. |
| No Disc | Disc is dirty | Clean disc with soft cloth |
| | Disc is upside down | Insert disc with label side up |
| | Disc not present in loading compartment | Insert disc |
| Unsupported Disc | Disc is dirty | Clean disc with soft cloth |
| | Disc is upside down | Insert disc with label side up |
| Unknown disc | Disc format is not compatible with this unit | Change another disc. |
| Region Error | DVD is not compatible with region code of unit | Use discs with corresponding regional code. |
| Error | Illegal mechanism operation | Press EJECT key for 5 seconds to reset loading mechanism |

If an error display other than the ones described above appears, press the **[RESET]** button. If the problem persists, turn off the power and consult your store of purchase.

* When the **[RESET]** button is pressed, frequencies of radio stations, titles, etc. stored in memory are cleared.

17. SPECIFICATIONS

FM Tuner

Frequency range: 87.5-108.0MHz
 Usable sensitivity: 13dBf
 Frequency response: 30Hz-15kHz
 Stereo separation: 30dB(1kHz)
 Signal/noise ratio: >55dB

AM Tuner

Frequency range: 531-1602kHz
 Usable sensitivity (S/N=20dB): 30dB μ

Disc Player

System: Disc digital audio system
 Frequency response: 20Hz-20kHz
 Signal/noise ratio: >93dB
 Total harmonic distortion: Less than 0.1% (1kHz)
 Channel separation: >60dB
 Video signal output: NTSC
 Video output level: 1 \pm 0.2V

MP3/WMA mode

MP3 sampling rate: 8 kHz to 48 kHz
 MP3 bit rate: 8 kbps to 320 kbps / VBR
 WMA bit rate: 8 kbps to 320 kbps

USB

Specification: USB 1.0/2.0

Playable audio format:

MP3(.mp3): MPEG 1/2/Audio Layer-3
 MP4(.MPEG4 / .AAC / DivX 3.11/4.0/5.0/6.0 /7.0)
 WMA(.wma): Ver 7/8/9.1/9.2

Playable video format:

AVI,MP4,MPG/MPEG,3GP
 480x272

SD

Memory cards:

Standard SD/SDHC, micro SD/SDHC

File system: FAT, FAT16, FAT32

Playable audio format:

MP3(.mp3): MPEG 1/2/Audio Layer-3
 MP4(.MPEG4 / .AAC)
 WMA(.wma): Ver 7/8/9.1/9.2

Playable video format:

AVI,MP4,MPG/MPEG,3GP
 480x272

Bluetooth

Specification: Bluetooth Ver. 2.0+EDR

Profile: HFP (Hands-free Profile)

A2DP (Advanced Audio Distribution Profile)

AVRCP (AV Remote Control Profile)

PBAP (Phone Book Access Profile)

Send/Receive Sensitivity: Class 2

Audio Amplifier

Maximum power output:

200W (50W x 4)

Speaker impedance: 4 Ω (4 to 8 Ω allowable)

6.2 Inch TFT LCD

Display resolution (dot): 800RGB (H) x 480(V)

Active area (mm): 137.52(H) x 77.232 (V)

Screen size (inch): 6.2 (Diagonal)

Dot pitch (mm): 0.1719(H) x 0.1609(V)

Input

Audio input sensitivity:

High: 320mV (at 2V output)

Mid: 650mV (at 2V output)

Low: 1.3V (at 2V output)
 (input impedance 10 k Ω or greater)

AUX-in Audio level : \leq 2V

Video level : NTSC/PAL 1Vp-p@75 Ω

General

Power supply voltage:

14.4VDC (10.8 to 15.6V allowable),
 negative ground

Pre-Amp output voltage:

4.0V (CD play mode: 1kHz, 0dB, 10k Ω load,
 volume max.)

Fuse: 15A

Dimensions of the Main Unit:

178mm Width x 100mm Height x 163mm Depth

Weight of the Main Unit: 1.90kg

Dimensions of the Remote Control unit:

49mm Width x 12mm Height x 139mm Depth

Weight of the Remote Control Unit:

55g (including battery)

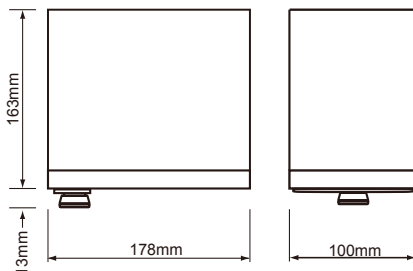

Note:

- Specifications and design are subject to change without notice for further improvement.

18. WIRING AND CONNECTIONS

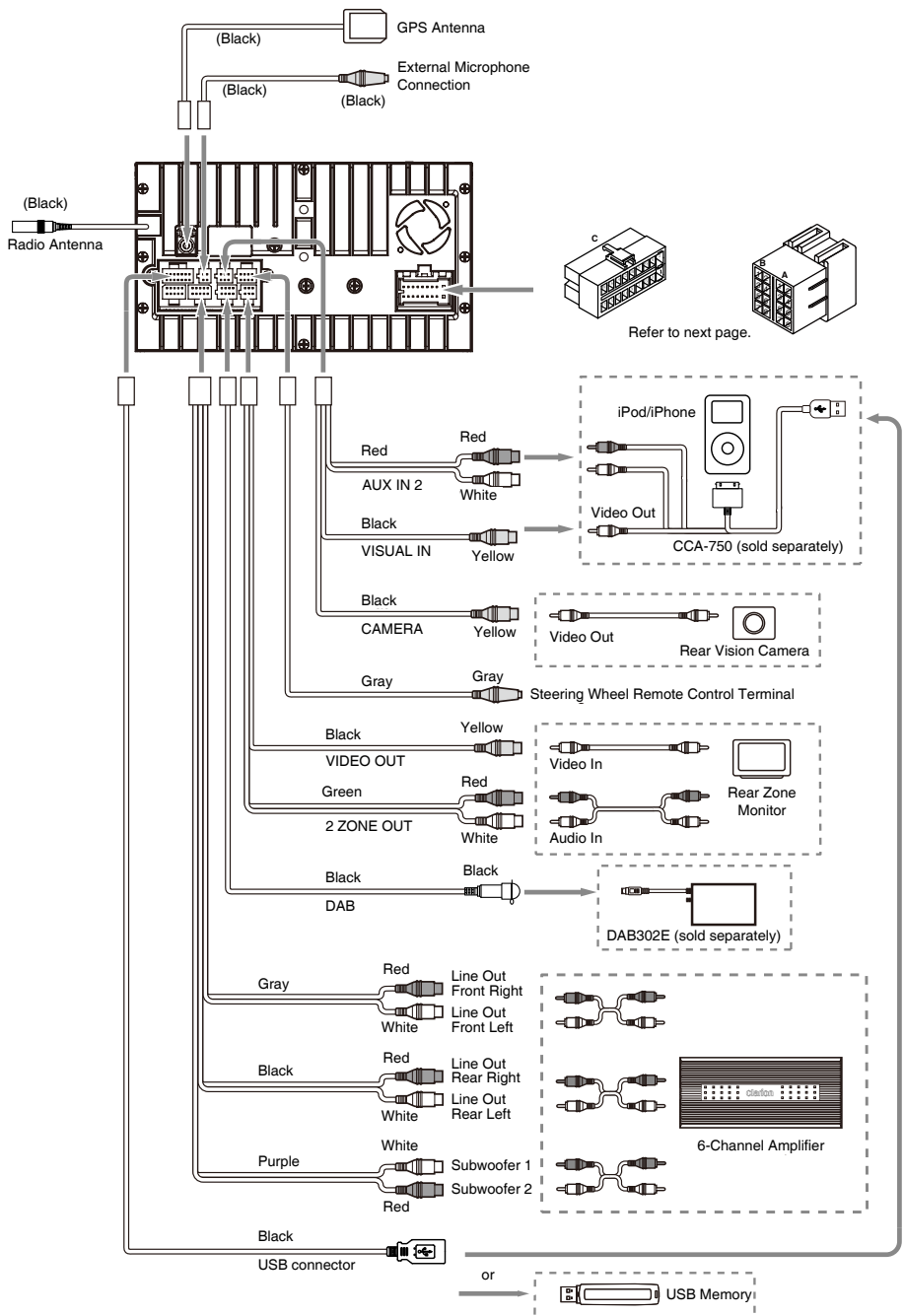

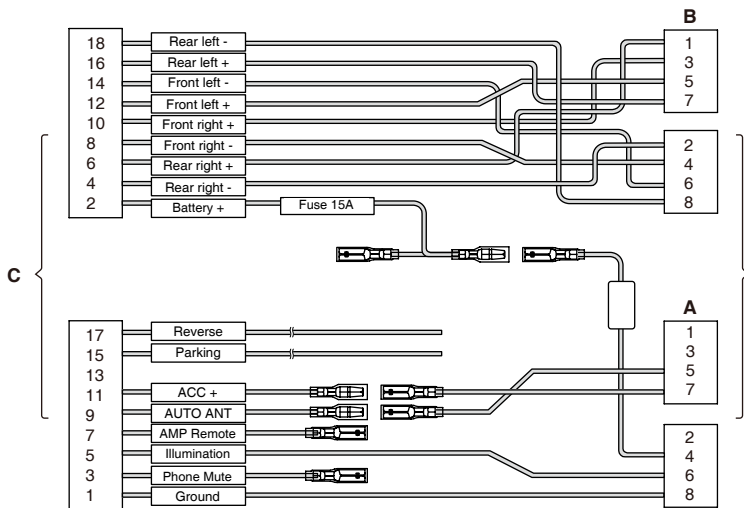

| Location | Function | |
|----------|---|---|
| | Connector A | Connector B |
| 1 | | Rear right (+) / Purple |
| 2 | | Rear right (-) / Purple with black stripe |
| 3 | | Front right (+) / Gray |
| 4 | Battery 12V(+) / Yellow | Front right (-) / Gray with black stripe |
| 5 | Auto Antenna / Blue | Front left (+) / White |
| 6 | Illumination / Orange with white stripe | Front left (-) / White with black stripe |
| 7 | ACC+ / Red | Rear left (+) / Green |
| 8 | Ground / Black | Rear left (-) / Green with black stripe |

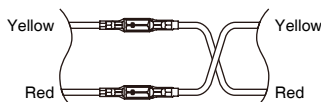

VW, Audi

Clarion Co., Ltd.

All Rights Reserved. Copyright © 2012: Clarion Co., Ltd.

Printed in China

clarion®

Owner's manual

NX502E

■ **Navigation**

Thank you for choosing the Clarion NX502E as your navigator. Start using Clarion NX502E right away. This document is the detailed description of the navigation software. You can easily discover Clarion Mobile Map while you are using it; however, we still recommend that you read this manual to fully understand the features and functions.



clarion.naviextras.com

Easy navigation map updates

It is easy to keep the navigation system up to date. Simply download new map data from Clarion's portal site, store them on a microSD card and insert it into the Clarion NX502E via the front card slot.

Latest Map Guarantee

When you start using the product, you have 30 days to download the latest available map free of charge.

Table of contents

| | |
|---|-----------|
| 1 Warnings and Safety information | 6 |
| 2 Getting started..... | 7 |
| 2.1 <i>Buttons and other controls on the screen.....</i> | 8 |
| 2.1.1 Using keyboards | 10 |
| 2.1.2 Beyond single screen tap | 11 |
| 2.2 <i>Map screen.....</i> | 12 |
| 2.2.1 Navigating on the map..... | 12 |
| 2.2.2 Position markers | 14 |
| 2.2.2.1 <i>Vehimarker and Lock-on-Road.....</i> | 14 |
| 2.2.2.2 <i>Selected map location (Cursor) and selected map object</i> | 14 |
| 2.2.3 Objects on the map | 14 |
| 2.2.3.1 <i>Streets and roads</i> | 14 |
| 2.2.3.2 <i>Turn preview and Next street.....</i> | 15 |
| 2.2.3.3 <i>Lane information and Signposts.....</i> | 16 |
| 2.2.3.4 <i>Junction view</i> | 17 |
| 2.2.3.5 <i>Motorway exit services</i> | 17 |
| 2.2.3.6 <i>3D object types.....</i> | 18 |
| 2.2.3.7 <i>Elements of the active route.....</i> | 18 |
| 2.2.3.8 <i>Traffic events</i> | 19 |
| 2.2.4 Manipulating the map | 20 |
| 2.2.5 Quick menu..... | 21 |
| 2.2.6 Checking the details of the current position (Where Am I?) | 24 |
| 2.3 <i>Navigation Menu.....</i> | 25 |
| 3 On-road navigation | 27 |
| 3.1 <i>Selecting the destination of a route.....</i> | 27 |
| 3.1.1 Entering an address or a part of the address..... | 27 |
| 3.1.1.1 <i>Entering an address.....</i> | 28 |
| 3.1.1.2 <i>Entering the midpoint of a street as the destination.....</i> | 30 |
| 3.1.1.3 <i>Selecting an intersection as the destination</i> | 31 |
| 3.1.1.4 <i>Selecting a city/town centre as the destination.....</i> | 33 |
| 3.1.1.5 <i>Entering an address with a postal code</i> | 34 |
| 3.1.1.6 <i>Tips on entering addresses quickly.....</i> | 36 |
| 3.1.2 Selecting the destination from the Places of Interest | 37 |
| 3.1.2.1 <i>Quick search for a Place of Interest.....</i> | 37 |
| 3.1.2.2 <i>Searching for a Place of Interest using preset categories.....</i> | 38 |
| 3.1.2.3 <i>Searching for a Place of Interest by category.....</i> | 40 |
| 3.1.2.4 <i>Searching for a Place of Interest by name</i> | 43 |
| 3.1.2.5 <i>Searching for a Place of Interest by its Phone Number</i> | 46 |
| 3.1.2.6 <i>Selecting nearby assistance from 'Where Am I?'</i> | 47 |
| 3.1.3 Selecting a map location as the destination | 49 |
| 3.1.4 Selecting the destination from your Favourites | 49 |

| | | |
|----------|--|-----------|
| 3.1.5 | Selecting your Home location..... | 50 |
| 3.1.6 | Selecting a recent destination from the History | 51 |
| 3.1.7 | Entering the Coordinate of the destination | 52 |
| 3.1.8 | Navigate to a location stored in a photo..... | 54 |
| 3.1.9 | Building a route from the list of destinations (Create Route) | 55 |
| 3.2 | <i>Viewing the entire route on the map</i> | 56 |
| 3.3 | <i>Checking route parameters and accessing route related functions</i> | 56 |
| 3.4 | <i>Modifying the route</i> | 57 |
| 3.4.1 | Selecting a new destination when already having a route: New Route, Waypoint or Final Destination..... | 57 |
| 3.4.2 | Setting a new starting position for the route | 58 |
| 3.4.3 | Editing the list of destinations (Edit Route)..... | 59 |
| 3.4.4 | Pausing the active route | 60 |
| 3.4.5 | Cancelling the active route | 60 |
| 3.4.6 | Checking route alternatives when planning the route | 61 |
| 3.4.7 | Checking route alternatives for an existing route | 62 |
| 3.4.8 | Changing the vehicle used in route planning | 63 |
| 3.4.9 | Changing the road types used in route planning | 64 |
| 3.5 | <i>Saving a location as a Favourite destination</i> | 65 |
| 3.6 | <i>Saving a location as an alert point</i> | 66 |
| 3.7 | <i>Editing an alert point</i> | 67 |
| 3.8 | <i>Watching the simulation of the route</i> | 68 |
| 4 | Off-road navigation..... | 70 |
| 4.1 | <i>Selecting the destination of the route</i> | 70 |
| 4.2 | <i>Navigating in off-road mode</i> | 70 |
| 5 | Reference Guide | 71 |
| 5.1 | <i>Concepts</i> | 71 |
| 5.1.1 | Smart Zoom | 71 |
| 5.1.2 | Daytime and night colour themes | 71 |
| 5.1.3 | Tunnel view | 71 |
| 5.1.4 | Route calculation and recalculation | 72 |
| 5.1.5 | Green routing | 74 |
| 5.1.6 | Road safety cameras and other proximity alert points | 74 |
| 5.1.7 | Speed limit warning | 75 |
| 5.1.8 | Traffic information in route planning | 76 |
| 5.1.8.1 | <i>Real-time traffic information (TMC)</i> | 76 |
| 5.2 | <i>'More' menu</i> | 78 |
| 5.3 | <i>Settings menu</i> | 79 |
| 5.3.1 | Sound and Warnings..... | 80 |
| 5.3.2 | Customise Quick menu | 82 |
| 5.3.3 | Traffic settings | 82 |

| | |
|--|-----------|
| 5.3.4 Route settings..... | 83 |
| 5.3.5 User profiles..... | 87 |
| 5.3.6 Map settings..... | 87 |
| 5.3.7 Visual guidance settings | 89 |
| 5.3.8 Display settings..... | 90 |
| 5.3.9 Regional settings..... | 90 |
| 5.3.10 Trip monitor settings..... | 91 |
| 6 Glossary..... | 92 |
| 7 End User Licence Agreement..... | 94 |
| 8 Copyright note..... | 94 |

1. Warnings and Safety information

The navigation system helps you find your way to your destination with a connected GPS receiver. Clarion Mobile Map does not transmit your GPS position; others cannot track you.

It is important that you look at the display only when it is safe to do so. If you are the driver of the vehicle, we recommend that you operate Clarion Mobile Map before you start your journey. Plan the route before your departure and stop if you need to change the route.

You must obey the traffic signs and follow the road geometry. If you deviate from the recommended route, Clarion Mobile Map changes the instructions accordingly.

Never place where it obstructs the driver's view, where it is in the deployment zone of an airbag or where it might cause injuries in an accident.

For more information, consult the End User Licence Agreement (page 94).

2. Getting started

Clarion Mobile Map is optimised for in-car use. You can use it easily by tapping the screen buttons and the map with your fingertips.

When using the navigation software for the first time, an initial setup process starts automatically. Do as follows:

1. Select the written language of the application interface. Later you can change it in Regional settings (page 90).



2. Read the End User Licence Agreement. Tap  to continue.



3. The Configuration wizard starts. Tap  to continue.

4. Select the language and speaker used for voice guidance messages. Later you can change it in Sound and Warnings settings (page 90).



5. If needed, modify the time format and unit settings. Later you can change them in Regional settings (page 90).

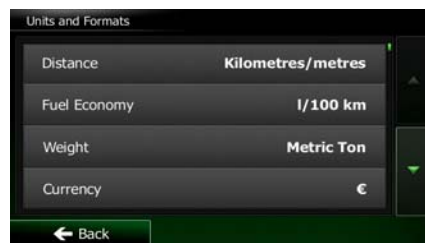

- If needed, modify the default route planning options. Later you can change them in Route settings (page 83).

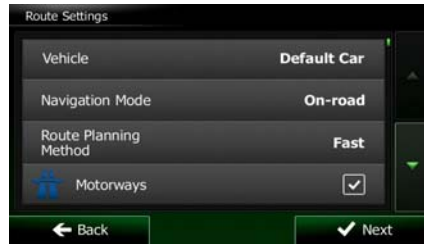









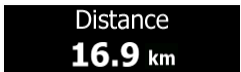

- The initial setup is now complete. The Configuration wizard can be restarted later from the Settings menu (page 79).

After the initial setup, the Map screen appears and you can start using Clarion Mobile Map.

2.1 Buttons and other controls on the screen









When you are using Clarion Mobile Map, you usually tap buttons on the touch screen.

| Type | Example | Description | How to use it |
|-------------------|---|---|---|
| Button |  | Tap it to initiate a function, to open a new screen, or to set a parameter. | Tap it once. |
| Button with value |  | Some buttons display the current value of a field or setting. Tap the button to change the value. After the change, the new value is shown on the button. | Tap it once. |
| Icon |  | Shows status information. | Some icons also function as a button. Tap them once. |
| List |  | When you need to select from several options, they appear in a list. | Grab the list anywhere and slide your finger up or down. Depending on the speed of the sliding, the list will scroll fast or slow, only a bit or till the end. Alternatively, move between pages with the  and  buttons and tap the value that you want. |

| | | | |
|------------------|--|--|---|
| Radio button |  | When there are only a few choices, radio buttons may be used instead of lists. Only one value can be selected. | Tap one of the buttons to select a new value. |
| Switch |  | When there are only two choices, a checkmark shows whether the feature is enabled. | Tap it to turn the switch on or off. |
| Slider |  | When a feature can be set to different values in a range, Clarion Mobile Map shows an indicator on a gauge that displays and sets the value. | <ul style="list-style-type: none"> • Drag the handle to move the slider to its new position. • Tap the slider where you want the handle to appear; the thumb jumps there. |
| Virtual keyboard |  | Alphabetic and alphanumeric keyboards to enter text and numbers. | Each key is a touch screen button. |











2.1.1 Using keyboards

You only need to enter letters or numbers when needed. You can type with your fingertips on the full-screen keyboards and you can switch between various keyboard layouts, for example English, Greek or numerical.

| Task | Instruction |
|--|--|
| Switching to another keyboard layout, for example from an English keyboard to a Greek keyboard | Tap the  button and select the new keyboard layout from the list. |
| Correcting your entry on the keyboard | Tap  to remove the unneeded character(s). Tap and hold the button to delete several characters or the entire input string. |
| Entering a space, for example between a first name and a family name or in multi-word street names | Tap the  button at the bottom centre of the screen. |
| Entering upper and lower case letters | When entering a text, the first character appears in upper case while the rest of the text is in lower case. Tap  to enter an upper case letter or tap twice to turn on Caps Lock. Tap again and lower case letters return. |
| Entering numbers and symbols | Tap  to switch to a keyboard offering numeric and symbol characters. |
| Finalising the keyboard entry (accepting the suggested search result) | Tap  . |
| Finalising the keyboard entry (opening the list of search results) | Tap  . |
| Finalising the keyboard entry (saving your input) | Tap  . |
| Cancelling the keyboard entry (returning to the previous screen) | Tap  . |

2.1.2 Beyond single screen tap

You usually need to tap the screen only once. However, some useful features can be accessed with combined touch screen tapping. Those are the following:

| Action | Details |
|--------------------------------|--|
| Tapping and holding the screen | <p>Tap and keep pressing the following buttons to reach extra functions:</p> <ul style="list-style-type: none"> • Tap and hold  on list and menu screens: the Map screen appears. • Tap and hold any of the , , , , , and  buttons on the Map screen: you can rotate, tilt or scale the map continuously. • Tap and hold  on keyboard screens: you can delete several characters quickly. • Tap and hold  or  in long lists: you can scroll pages continuously. |
| Gestures (drag&drop) | <p>You need to drag and drop the screen only in cases like:</p> <ul style="list-style-type: none"> • Moving the handle on a slider. • Scrolling the list: grab the list anywhere and slide your finger up or down. Depending on the speed of the sliding, the list will scroll fast or slow, only a bit or till the end. • Moving the map in map browsing mode: grab the map, and move it in the desired direction. |

2.2 Map screen

2.2.1 Navigating on the map

A small live map is displayed on the Navigation Menu, as a part of the button.

Show Map



To enlarge this small map and open the Map screen, tap

Show Map

This map shows the current position (the Vehimarker, a red arrow by default), the recommended route (an orange line), and the surrounding map area.

When there is no GPS position, the Vehimarker is transparent. It shows your last known position.

You see coloured dots circling around a satellite symbol in the top left corner. The more green dots you see, the closer you are to get the valid GPS position.



When GPS position is available, the Vehimarker is displayed in full colour, now showing your current position.



There are screen buttons and data fields on the screen to help you navigate. During navigation, the screen shows route information.

By default, only one data field is displayed in the bottom right corner. Tap this field to see all route data fields. Tap any of the data fields to suppress others and display only the selected one.

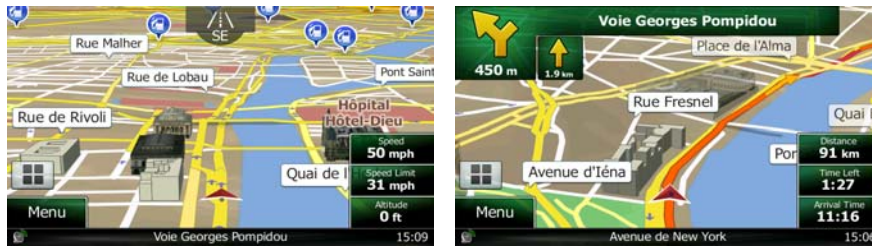

The data fields are different when you are navigating an active route and when you have no specified destination (the orange line is not displayed).

Default data fields when cruising without a destination (tap and hold any of the fields to change its value):

| Field | Description |
|-------------------------------|---|
| Speed 61 km/h | Shows your current speed given by the GPS receiver. |
| Speed Limit 70 km/h | Shows the speed limit of the current road if the map contains it. |
| Time 17:11 | Shows the current time corrected with time zone offset. The accurate time comes from the GPS satellites, and the time zone information comes from the map or it can be set manually in Regional settings. |

Default data fields when navigating a route (tap and hold any of the fields to change its value):

| Field | Description |
|------------------------------|--|
| Distance 16.9 km | Shows the distance you need to travel on the route before reaching your final destination. |
| Time Left 0:16 | Shows the time needed to reach the final destination of the route based on information available for the remaining segments of the route. If Clarion NX502E is capable of receiving live traffic information, the calculation takes into account traffic delays affecting your route if they are received. However, this calculation is rarely accurate. |
| Arrival Time 17:22 | Shows the estimated arrival time at the final destination of the route based on information available for the remaining segments of the route. If Clarion NX502E is capable of receiving live traffic information, the calculation takes into account traffic delays affecting your route if they are received. However, this calculation is rarely accurate. |

2.2.2 Position markers

2.2.2.1 Vehimarker and Lock-on-Road

When your GPS position is available, Clarion Mobile Map marks your current position with the Vehimarker. By default, this marker is a red arrow, but you can change this icon in Settings.

When on-road navigation is selected, the Vehimarker may not show your exact GPS position and heading. If roads are near, it is aligned to the nearest road to suppress GPS position errors, and the direction of the icon is aligned to the direction of the road.

If you select off-road navigation: The Vehimarker is at your exact GPS position. The direction of the icon shows your current heading.

2.2.2.2 Selected map location (Cursor) and selected map object

You can mark a map location in the following ways:

- Tap the map when navigating
- Tap the map when you are asked to confirm the destination at the end of a search
- Tap the map in Find on Map (page 49)

When a map location is selected, the Cursor appears at the selected point on the map. The

Cursor is displayed with a radiating red dot () to make it visible at all zoom levels.

The location of the Cursor can be used as the destination of the route, a new alert point, you can search for Places around it, or you can save this location as one of your Favourite destinations.

You can also select some of the objects on the map. If you tap the map at the icon of a Place of Interest or an alert point, the object will be selected (you see a red circling border around the object), and you can get information about this object or use it as a route point.

2.2.3 Objects on the map

2.2.3.1 Streets and roads

Clarion Mobile Map shows the streets in a way that is similar to how the paper road maps show them. Their width and colours correspond to their importance: you can easily tell a motorway from a small street.

2.2.3.2 Turn preview and Next street

When navigating a route, the top section of the Map screen shows information about the next route event (manoeuvre) and the next street or the next city/town.







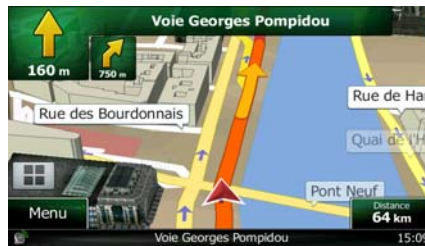

There is a field in the top left corner that displays the next manoeuvre. Both the type of the event (turn, roundabout, exiting motorway, etc.) and its distance from the current position are displayed.

A smaller icon shows the type of the second next manoeuvre if it is near the first one. Otherwise, only the next manoeuvre is displayed.



Most of these icons are very intuitive. The following table lists some of the frequently shown route events. The same symbols are used in both fields:

| Icon | Description |
|------|---|
| | Turn left. |
| | Turn right. |
| | Turn back. |
| | Bear right. |
| | Turn sharp left. |
| | Keep left. |
| | Continue straight in the intersection. |
| | Go left on the roundabout, 3rd exit (next manoeuvre). |
| | Enter roundabout (second next manoeuvre). |

| | |
|---|------------------------------|
|  | Enter motorway. |
|  | Exit motorway. |
|  | Board ferry. |
|  | Leave ferry. |
|  | Approaching a waypoint. |
|  | Approaching the destination. |

2.2.3.3 Lane information and Signposts

When navigating on multi-lane roads, it is important to take the appropriate lane in order to follow the recommended route. If lane information is available in the map data, Clarion Mobile Map displays the lanes and their directions using small arrows at the bottom of the map. Highlighted arrows represent the lanes you need to take.

Where additional information is available, signposts substitute arrows. Signposts are displayed at the top of the map. The colour and style of the signposts are similar to the real ones you can see above road or by the roadside. They show the available destinations and the number of the road the lane leads to.

All signposts look similar when cruising (when there is no recommended route). When navigating a route, only the signpost that points to the lane(s) to be taken is displayed in vivid colours; all others are darker.

If you want to hide the currently displayed signposts, tap any of them and the normal Map screen returns until new signpost information is received.



2.2.3.4 Junction view

If you are approaching a motorway exit or a complex intersection and the needed information exists, the map is replaced with a 3D view of the junction. The lanes you need to take are displayed with arrows. Signposts can also be present if information is available.

If you want to hide the currently displayed junction, tap the picture and the Map screen returns.



2.2.3.5 Motorway exit services

You may need a petrol station or a restaurant during your journey. This feature displays a new button on the map when you are driving on motorways.



Tap this button to open a panel with the details of the next few exits or service stations.



Tap any of them to display it on the map and add it as a waypoint to your route if needed.

If you want to display other types of Places for the exits, you can change the icons in Visual Guidance settings (page 89).



2.2.3.6 3D object types

Clarion Mobile Map supports the following 3D object types:

| Type | Description |
|----------------|--|
| 3D terrain | 3D terrain map data shows changes in terrain, elevations or depressions in the land when you view the map in 2D, and use it to plot the route map in 3D when you navigate. Hills and mountains are shown in the background of the 3D map, and illustrated by colour and shading on the 2D map. |
| Elevated roads | Complex intersections and vertically isolated roads (such as overpasses or bridges) are displayed in 3D. |
| 3D landmarks | Landmarks are 3D artistic or block representations of prominent or well-known objects. |
| 3D buildings | 3D block representation of full city building data containing actual building size and position on the map. |

2.2.3.7 Elements of the active route

Clarion Mobile Map shows the route in the following way:

| Symbol | Name | Description |
|---|---|--|
|  | Current GPS position and Start point | Your current position displayed on the map. If roads are near, it is aligned to the nearest road. Normally if GPS position is available, the route starts from the current position. If there is no valid GPS position, Clarion Mobile Map uses the last known position as the start point. |
|  | Waypoint (intermediate destination) | An intermediate destination of the route before reaching the final destination. |
|  | Destination (end point) | The final destination of the route. |
| | Route colour | The route always stands out with its colour on the map, both in daytime and in night colour mode. |
| | Streets and roads that are excluded from the navigation | You can choose whether you want to use or avoid certain road types (page 83). However, when Clarion Mobile Map cannot avoid such roads, the route will include them and it will show them in a colour that is different from the route colour. |
| | Streets and roads that are affected by traffic events | Road segments may be affected by traffic events received. These streets and roads are displayed in an alternate colour, and small symbols displayed along the route show the type of the traffic event. |

2.2.3.8 Traffic events

Road segments affected by traffic events are displayed with an alternate colour on the map, and small symbols above the road show the nature of the event:



Tap  to open the Traffic Summary screen.





Tap  Event List to open the list of traffic events:



Now tap any of the list items to see its details, and to display the affected road segment in its full length on the map:









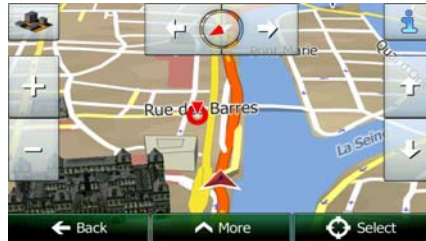



 **Note!** If there are traffic events on the recommended route that the application has not bypassed, the  icon will open the list of significant traffic events to let you quickly check them.

2.2.4 Manipulating the map

Tap the map anywhere to browse it during navigation. The map stops following the current position (the Vehimarker, a red arrow by default, is not locked in a fix position on the screen any more) and control buttons appear to help you modify the map view.



| Action | Button(s) | Description |
|-------------------------------|---|---|
| Moving the map with drag&drop | No buttons | You can move the map in any direction: tap and hold the map, and move your finger towards the direction you want to move the map. |
| Zooming in and out |  | <p>Changes how much of the map is displayed on the screen.</p> <p>Clarion Mobile Map uses high-quality vector maps that let you examine the map at various zoom levels, always with optimised content. It always displays street names and other text with the same font size, never upside-down, and you only see the streets and objects that you need.</p> <p>Map scaling has a limit in 3D map view mode. If you zoom out further, the map switches to 2D view mode.</p> <p>Tap the button once to modify the view in large steps, or tap and hold the button to modify it continuously and smoothly.</p> |
| Tilting up and down |  | <p>Changes the vertical view angle of the map in 3D mode.</p> <p>Tap the button once to modify the view in large steps, or tap and hold the button to modify it continuously and smoothly.</p> |
| Rotating left and right |  | <p>Changes the horizontal view angle of the map.</p> <p>Tap the button once to modify the view in large steps, or tap and hold the button to modify it continuously and smoothly.</p> |
| 2D or 3D view |  | Tap this button to switch between the 3D perspective and 2D top-down map view modes. |

| | | |
|-----------------------------|---|---|
| Compass in 2D map view mode |  | The direction of the compass shows North. Tap the button to switch to North-up view, and then tap again to rotate the map in the previous direction. |
| Compass in 3D map view mode |  | The direction of the compass shows North. Tap the button to switch to North-up view, and then tap again to rotate the map in the previous direction. |
| Location information |  | Tap this button to open a new screen with information about the selected map point, the Cursor. |
| Return to normal navigation |  | Tap this button to move the map back to follow the current GPS position. Automatic map rotation is also re-enabled. The map manipulation buttons disappear and navigation continues. |
| Additional options |  | Tap this button to open a list of additional features like saving the Cursor as a Favourite destination, or searching for Places around the Cursor. |
| Select destination |  | Tap this button to select the Cursor as a new destination. The route is automatically calculated. |

2.2.5 Quick menu









The Quick menu is a selection of controls and functions that are frequently needed during navigation. It can be opened directly from the Map screen by tapping .





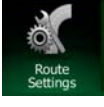
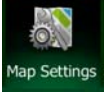

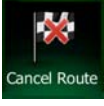
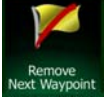
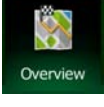

The menu will close after a few seconds of inactivity or if you tap .

Most of these functions are shortcuts. They are accessible from the menu system.

There are more functions available than the number of buttons in the menu. In Settings, you can choose the function of each button (page 82). The following options are available:

| Button | Description | Shortcut for |
|---|--|---|
|  | <p>This function lets you search for a Place along your route or around your current location if there is no route calculated.</p> | <p>Find / Find Places / Quick Search (page 37)</p> |
|  | <p>This button opens the list of your Favourite destinations.</p> | <p>Find / Favourite (page 49)</p> |
|  | <p>This button opens the History list. You can select one of your previous destinations.</p> | <p>Find / History (page 51)</p> |
|  | <p>This button opens the route editing function.</p> | <p>My Route / Edit Route</p> |
|  | <p>This button opens the route related settings.</p> | <p>More / Settings / Route Settings (page 83)</p> |
|  | <p>This button opens the map related settings.</p> | <p>More / Settings / Map Settings (page 87)</p> |
|  | <p>This button opens a special screen with information about the current position and a button to search for nearby emergency or roadside assistance. For details, see the next chapter.</p> | <p>Tap the Current Street field on the Map screen</p> |
|  | <p>This button cancels the route and stops navigation. The button is replaced with the next one if waypoints are given.</p> | <p>My Route / Cancel Route (page 60)</p> |
|  | <p>This button skips the next waypoint from the route.</p> | |
|  | <p>This button opens a 2D map scaled and positioned to show the entire route.</p> | <p>My Route / Overview (page 56)</p> |
|  | <p>This button opens the Visual Guidance settings screen.</p> | <p>More / Settings / Visual Guidance (page 89)</p> |

| | | |
|--|---|---|
|  <p>Traffic</p> | <p>This button opens the Traffic Summary screen.</p> | <p>Tap the Traffic icon in the Navigation Menu or on the Map screen</p> |
|  <p>Avoid</p> | <p>This button lets you bypass parts of the recommended route.</p> | <p>My Route / Avoidances</p> |
|  <p>Trip Monitor</p> | <p>This button opens the Trip Monitor screen where you can manage your previously saved trip logs and track logs.</p> | <p>More / Trip Monitor (page 78)</p> |
|  <p>Itinerary</p> | <p>This button opens the list of manoeuvres (the itinerary).</p> | <p>Tap the top of the Map screen during navigation.</p> |
|  <p>Save Route</p> | <p>With this function you can save the active route for later use.</p> | <p>My Route / More / Save Route</p> |
|  <p>Load Route</p> | <p>With this function you can replace the active route with a previously saved route.</p> | <p>My Route / More / Load Route</p> |
|  <p>Find Places</p> | <p>With this function you can search for Places of Interest in various different ways.</p> | <p>Find / Find Places (page 37)</p> |
|  <p>Simulate Navigation</p> | <p>This button opens the Map screen and starts simulating the active route.</p> | <p>My Route / More / Simulate Navigation (page 68)</p> |
|  <p>GPS Info</p> | <p>This button opens the GPS Information screen with satellite position and signal strength information.</p> | <p>Tap the top of the Map screen when there is no GPS reception</p> |
|  <p>Home</p> | <p>This button offers your Home location as a destination.</p> | |
|  <p>Vehicle Profile</p> | <p>This button opens the parameters of the selected Vehicle profile.</p> | <p>More / Settings / Route (page 83)</p> |

2.2.6 Checking the details of the current position (Where Am I?)

This screen contains information about the current position (or about the last known position if GPS reception is not available) and a button to search for useful Places nearby.





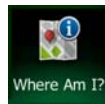

You can access this screen from the map in one of the following ways:

- If the current street is displayed below the Vehimarker (the current position on the map), tap it to open the Where Am I? screen.





- Open the Quick menu and tap the  button.

Information on this screen:

-  : Latitude and Longitude (coordinate of the current position in WGS84 format).
- : Altitude (elevation information coming from the GPS receiver - often inaccurate).
- : House number on the left.
- : House number on the right.
- In the middle of the screen you can see whether the position is current, or the time left since it was last updated.
- Address details (when available) of the current position are also displayed at the bottom.



You can also perform some actions on this screen:

Tap  to save the current position as a Favourite destination.

You can also search for assistance near your current position. Tap  to open a new screen for the Quick search:



The following services can be searched around the current position or the last known position:

-  Car Repair Around Here : Car repair and roadside assistance services
-  Police Around Here : Police stations
-  Health Around Here : Medical and emergency services
-  Petrol Station Around Here : Petrol stations



Tap any of the buttons, select a Place from the list, and navigate to it.

2.3 Navigation Menu



You can reach all parts of Clarion Mobile Map from the Navigation Menu.



You have the following options:

- Tap  Find to select your destination by entering an address or selecting a place of interest, a location on the map or one of your Favourite destinations. You can also look up your recent destinations from the Smart History or enter a coordinate.
- Tap  My Route to display the route parameters and the route in its full length on the map. You can also perform route-related actions such as editing or cancelling your route, setting a start point for the route, picking route alternatives, avoiding parts of the route, simulating navigation or adding the destination to your Favourites.
- Tap  More... to customise the way the navigation software works, to simulate demo routes or to run some additional applications.

Show Map

- Tap  to start navigating on the map. The button itself is a miniature live map that shows your current position, the recommended route and the surrounding map area. Tap the button to enlarge the map to the full screen.
- Tap  to open the Traffic Summary screen.

3 On-road navigation

When first started, Clarion Mobile Map calculates routes using the road network of the high quality vector maps provided with the product.

You can set up your route in different ways:

- If you need a route for immediate navigation, you can select the destination and start navigating to it right away (normal navigation).
- You can also plan a route independently of your current GPS position or even without GPS reception (to achieve this, you need to turn off the GPS receiver and set a new starting point in My Route / Edit Route by tapping the flag icon at the current position).

You can plan routes with multiple destinations. Select the first destination. Then select a second destination and add it to your route to create a multi-point route. You can add as many destinations to your route as you like.

You can also use Clarion Mobile Map for off-road navigation. For details, see page 70.

3.1 Selecting the destination of a route

Clarion Mobile Map offers you several ways of choosing your destination:

- Enter a full address or a part of an address, for example a street name without a house number or the names of two intersecting streets (page 27).
- Enter an address with postal code (page 34). This way you do not need to select the name of the city/town and the search for street names might be faster as well.
- Use a built-in Place of Interest as your destination (page 37).
- Select a location on the map with the Find on Map feature (page 49).
- Use a previously saved Favourite destination (page 49).
- Select a location from the History of previously used destinations (page 51).
- Enter the coordinate of the destination (page 52).
- Use the location where a photo was taken (page 54).

3.1.1 Entering an address or a part of the address

If you know at least a part of the address, it is the quickest way to select the destination of the route.



Using the same screen, you can find an address by entering:

- the exact address, including house number
- the centre of a city/town
- an intersection
- the midpoint of a street
- any of the above, starting the search with the postal code (page 34)

3.1.1.1 Entering an address

To enter an address as the destination, do as follows:



1. If you are on the Map screen, tap  to return to the Navigation Menu.

2. In the Navigation Menu, tap the following buttons:  , .
3. By default, Clarion Mobile Map proposes the country and city/town where you are. If

needed, tap , enter the first few letters of the country name on the keyboard, and select one country from the list of results.

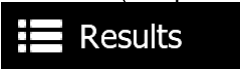

4. If needed, select a new city/town:

- a. Tap .
- b. Start entering the name of the city/town on the keyboard.
- c. Find the city/town you need:
 - The most likely city/town name is always shown in the input field. To accept it, tap .
 - If the desired name does not show up, the names that match the string appear in a list after entering a couple of characters (to open the list of results before it appears automatically, tap ). Select the city/town from the list.

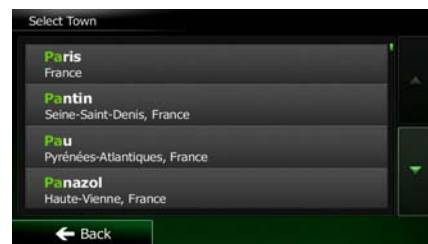

5. Enter the street name:

- a. Tap **Street**.
- b. Start entering the street name on the keyboard.
- c. Find the street you need:
 - The most likely street name is always shown in the input field. To accept it, tap .
 - If the desired name does not show up, the names that match the string appear in a list after entering a couple of characters (to open the list of results before it appears automatically, tap **☰ Results**). Select the street from the list.





6. Enter the house number:





- a. Tap **<House Number>**.
- b. Enter the house number on the keyboard. (To enter letters, tap **QWE**).
- c. Tap **✓ Done** to finish entering the address. (If the entered house number cannot be found, the midpoint of the street is selected as the destination.)



7. A full screen map appears with the selected point in the middle. If necessary, tap the map somewhere else to modify the destination. The Cursor () appears at the new location. Tap **➔ Next** to confirm the destination, or tap **⬅ Back** to select a different destination.





8. After a short summary of the route parameters, the map appears showing the entire route. The route is automatically calculated. Tap  to modify route parameters, or tap  and start your journey.



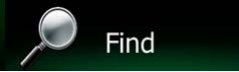

-  **Tip!** If you know that you will use this destination frequently, before tapping  to confirm the destination, put it on the list of your Favourites first: tap  then , give a name for the new Favourite, and tap  to save the location. The map with the destination returns automatically. Now you can start your journey.

3.1.1.2 Entering the midpoint of a street as the destination

You can navigate to the midpoint of a street if the house number is not available:

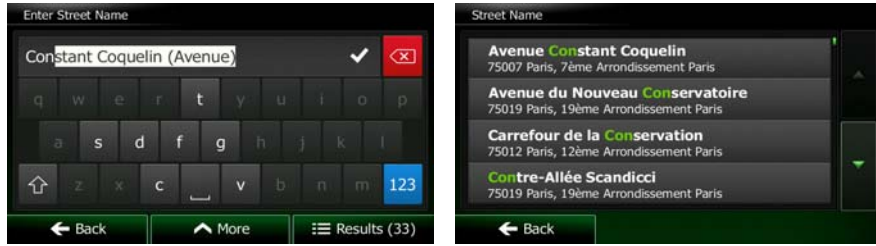
1. If you are on the Map screen, tap  to return to the Navigation Menu.
2. In the Navigation Menu, tap the following buttons: , .
3. If necessary, modify the country and city/town as described earlier (page 28).
4. Enter the street name:
 - a. Tap .
 - b. Start entering the street name on the keyboard.
 - c. Find the street you need:
 - The most likely street name is always shown in the input field. To accept it, tap .
 - If the desired name does not show up, the names that match the string appear in a list after entering a couple of characters (to open the list of results before it appears automatically, tap ). Select the street from the list.





5. Instead of entering the house number, tap . The midpoint of the street is selected as the destination.



6. A full screen map appears with the selected point in the middle. If necessary, tap the map somewhere else to modify the destination. The Cursor () appears at the

new location. Tap  to confirm the destination, or tap

 to select a different destination.

7. After a short summary of the route parameters, the map appears showing the entire route. The route is automatically calculated. Tap  to modify route



parameters, or tap  and start your journey.



3.1.1.3 Selecting an intersection as the destination



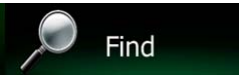

To enter an address as the destination, do as follows:

1. If you are on the Map screen, tap  to return to the Navigation Menu.

2. In the Navigation Menu, tap the following buttons:  

3. If necessary, modify the country and city/town as described earlier (page 28).

4. Enter the street name:

- a. Tap .
- b. Start entering the street name on the keyboard.
- c. Find the street you need:
 - The most likely street name is always shown in the input field. To accept it, tap .
 - If the desired name does not show up, the names that match the string appear in a list after entering a couple of characters (to open the list of results before it appears automatically, tap  **Results** ). Select the street from the list.





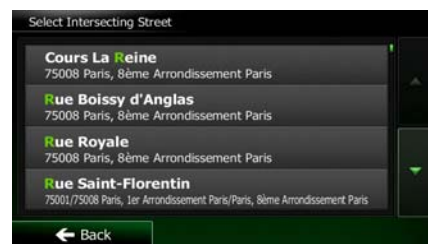

5. Enter the intersecting street name:

1. Tap .
- If only a few intersecting streets exist, their list appears immediately.
- In case of a longer street, the keyboard screen appears. Start entering the name of the intersecting street on the keyboard. As soon as the street names that match the entered string can be shown on one screen, their list appears automatically. Select from the list.

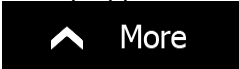

6. A full screen map appears with the selected point in the middle. If necessary, tap the map somewhere else to modify the destination. The Cursor () appears at the

new location. Tap  to confirm the destination, or tap  to select a different destination.

7. After a short summary of the route parameters, the map appears showing the entire route. The route is automatically calculated. Tap  to modify route parameters, or tap  and start your journey.



3.1.1.4 Selecting a city/town centre as the destination

The city/town centre is not the geometric centre of the city/town but an arbitrary point the map creators have chosen. In towns and villages, it is usually the most important intersection; in larger cities, it is one of the important intersections.

1. If you are on the Map screen, tap  to return to the Navigation Menu.

2. In the Navigation Menu, tap the following buttons:



3. If necessary, modify the country as described earlier (page 28).
4. Select the destination city/town:

- a. Tap .

- b. Start entering the name of the city/town on the keyboard.

- c. Find the city/town you need:

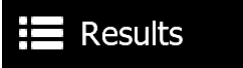

- The most likely city/town name is always shown in the input field. To accept it, tap .
- If the desired name does not show up, the names that match the string appear in a list after entering a couple of characters (to open the list of

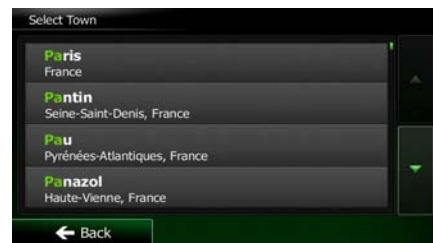

results before it appears automatically, tap ). Select the city/town from the list.



5. Instead of entering the street name, tap . This way the centre of the displayed city/town becomes the destination of the route.



6. A full screen map appears with the selected point in the middle. If necessary, tap the map somewhere else to modify the destination. The Cursor () appears at the new location. Tap  to confirm the destination, or tap  to select a different destination.



7. After a short summary of the route parameters, the map appears showing the entire route. The route is automatically calculated. Tap  to modify route parameters, or tap  and start your journey.



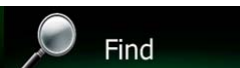

3.1.1.5 Entering an address with a postal code

All of the above address searching possibilities can be performed with entering the postal code instead of the city/town name. Find below an example with a full address:

1. If you are on the Map screen, tap  to return to the Navigation Menu.



2. In the Navigation Menu, tap the following buttons: , .
3. If necessary, modify the country as described earlier (page 28).
4. Enter a new city/town using its postal code:

- a. Tap .

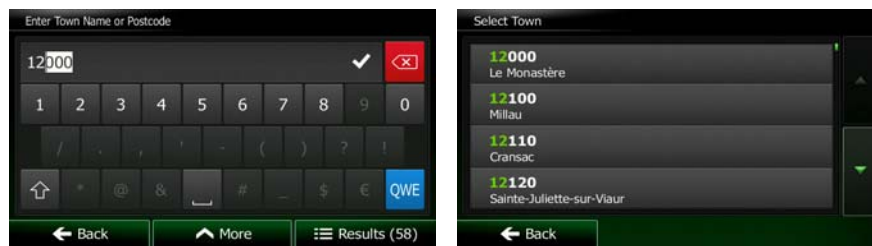
- b. Tap **123** to open the numeric keypad.
- c. Start entering the postal code.
- d. Find the city/town you need:
 - The most likely postal code is always shown in the input field. To accept it, tap .
 - If the desired number does not show up, open the list of results by tapping . Select the postal code from the list.



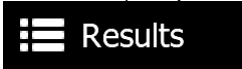

5. Enter the street name:

- a. Tap .
- b. Start entering the street name on the keyboard.
- c. Find the street you need:
 - The most likely street name is always shown in the input field. To accept it, tap .
 - If the desired name does not show up, the names that match the string appear in a list after entering a couple of characters (to open the list of results before it appears automatically, tap ). Select the street from the list.



6. Enter the house number:

- a. Tap .
- b. Enter the house number on the keyboard. (To enter letters, tap .



- c. Tap  to finish entering the address. (If the entered house number cannot be found, the midpoint of the street is selected as the destination.)



7. A full screen map appears with the selected point in the middle. If necessary, tap the map somewhere else to modify the destination. The Cursor () appears at the



new location. Tap  to confirm the destination, or tap

 to select a different destination.

8. After a short summary of the route parameters, the map appears showing the entire route. The route is automatically calculated. Tap  to modify route parameters, or tap  and start your journey.



3.1.1.6 Tips on entering addresses quickly

- When you are entering the name of a city/town or a street:
 - Only those letters are offered on the keyboard that appear in possible search results. All other characters are greyed out.
 - As you are typing, the most likely result is always displayed in the input field. If the guess is correct, tap  to select it.
 - After entering a couple of letters, tap  to list the items that contain the specified letters.
- You can speed up finding an intersection:
 - Search first for the street with a less common or less usual name; fewer letters are enough to find it.

- If one of the streets is shorter, search for that one first. You can then find the second one faster.
- You can search for both the type and the name of a road. If the same word appears in several names, for example in the name of streets, roads and avenues, you can obtain the result faster if you enter the first letter of the street type: For example, enter 'PI A' to obtain Pine Avenue and skip all Pine Streets and Pickwick Roads.
- You can also search in postal codes. As postal codes consist of only a few characters, this is usually faster than entering the name of the city/town.

3.1.2 Selecting the destination from the Places of Interest

You can select your destination from the Places of Interest included with Clarion Mobile Map.

Using the same screen, you can find a Place in different ways:

- with the Quick search feature, you can quickly find a nearby Place by its name
- with the Preset search feature, you can find frequently searched types of Places with only a few screen taps
- you can search for a Place by its category
- you can search for a Place by its name



In addition, you can search for special services from the 'Where Am I?' screen.

3.1.2.1 Quick search for a Place of Interest

The Quick search feature lets you quickly find a Place by its name. The search is always carried out

- along the recommended route if it exists or
- around your current location if there is no destination given.

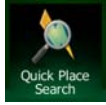
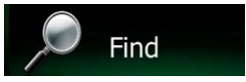
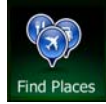
1. Start the Quick search function:

- If you are on the Map screen, tap  and then tap .
- If you are in the Navigation Menu, tap ,  and then tap .

2. Using the keyboard, start entering the name of the Place.





- After entering a few letters, tap  to open the list of Places with names containing the entered character sequence.



- (optional) The Places in the list are ordered by the length of the necessary detour (when navigating a route) or by their distance from the current position (when no destination is given). If you need to reorder the list, tap .

- Browse the list if necessary and tap one of the list items. A full screen map appears with the selected point in the middle. The name and address of the Place is displayed at the top of the screen.

- (optional) Tap  to see the details of the selected Place. Tap  to return to the map.

- If necessary, tap the map somewhere else to modify the destination. The Cursor



() appears at the new location. Tap  to confirm the

destination, or tap  to select a different destination.

- After a short summary of the route parameters, the map appears showing the entire

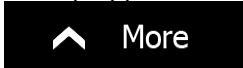
route. The route is automatically calculated. Tap  to modify route

parameters, or tap  and start your journey.

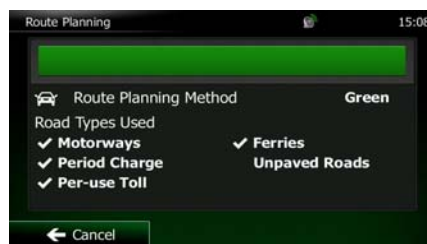

3.1.2.2 Searching for a Place of Interest using preset categories

The Preset search feature lets you quickly find the most frequently selected types of Places.

- If you are on the Map screen, tap  to return to the Navigation Menu.

2. In the Navigation Menu, tap the following buttons:

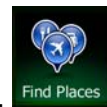

3. The preset search categories appear:

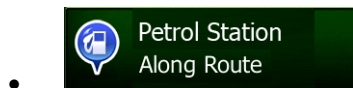

- If an active route exists, petrol stations are searched along the route.
- If there is no active route (destination is not selected), they are searched around the current position.
- If the current position is not available either (no GPS signal), they are searched around the last known position.

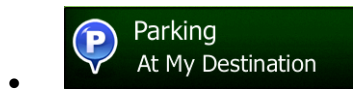

- If an active route exists, parking lots are searched around the destination of the route.
- If there is no active route (destination is not selected), they are searched around the current position.
- If the current position is not available either (no GPS signal), they are searched around the last known position.

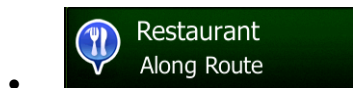

- If an active route exists, restaurants are searched along the route.
- If there is no active route (destination is not selected), they are searched around the current position.
- If the current position is not available either (no GPS signal), they are searched around the last known position.

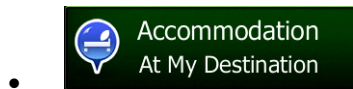

- If an active route exists, accommodation is searched around the destination of the route.
- If there is no active route (destination is not selected), they are searched around the current position.
- If the current position is not available either (no GPS signal), they are searched around the last known position.



4. Tap any of the quick search buttons to get an instant list of Places.



5. (optional) The Places in the list are ordered by their distance from the current or last known position, from the destination or by the length of the necessary detour. If you

need to reorder the list, tap .



6. Browse the list if necessary and tap one of the list items. A full screen map appears with the selected point in the middle. The name and address of the Place is displayed at the top of the screen.

7. (optional) Tap  to see the details of the selected Place. Tap  to return to the map.

8. If necessary, tap the map somewhere else to modify the destination. The Cursor

() appears at the new location. Tap  to confirm the destination, or tap  to select a different destination.

9. After a short summary of the route parameters, the map appears showing the entire

route. The route is automatically calculated. Tap  to modify route parameters, or tap  and start your journey.



3.1.2.3 Searching for a Place of Interest by category

You can search for Places of Interest by their categories and subcategories.

1. If you are on the Map screen, tap  to return to the Navigation Menu.

2. In the Navigation Menu, tap the following buttons: , .

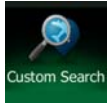

3. Tap
4. Select the area around which the Place should be searched for:

- Tap **Around Here** to search around the current position or if it is not available, around the last known position. (The result list will be ordered by the distance from this position.)
- Tap **In a Town** to search for a place within a selected city/town. (The result list will be ordered by the distance from the centre of the selected city/town.)
- Tap **Around Destination** to search for a place around the destination of the active route. (The result list will be ordered by the distance from the destination.)
- Tap **Along Route** to search along the active route, and not around a given point. This is useful when you search for a later stopover that results in a minimal detour only, such as searching for upcoming petrol stations or restaurants. (The result list will be ordered by the length of the necessary detour.)



5. (optional) If you have selected **In a Town**, select the city/town to search in.



6. Select one of the main Place categories (e.g. Accommodation) or tap **List All Places** to list all Places around the selected location or along the route.

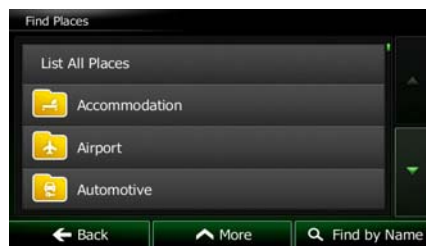

7. Select one of the Place subcategories (e.g. Hotel or Motel) or tap **List All Places** to list all Places in the selected main category around the selected location or along the route.

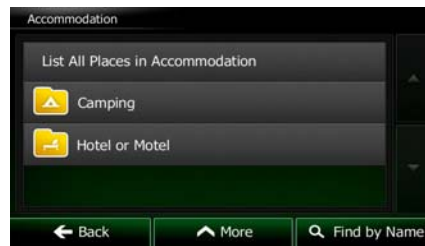

8. Sometimes the list of brands in the selected Place subcategory appears. Select one brand or tap **List All Places** to list all Places in the selected subcategory around the selected location or along the route.

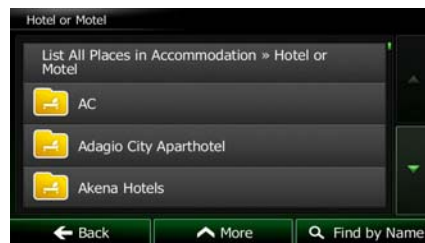

9. Finally, the results appear in a list.





10. (optional) The Places in the list are ordered by their distance from the current or last known position, from the selected city/town, from the destination or by the length of the necessary detour. If you need to reorder the list, tap **More**.

11. Browse the list if necessary and tap one of the list items. A full screen map appears with the selected point in the middle. The name and address of the Place is displayed at the top of the screen.

12. (optional) Tap **i** to see the details of the selected Place. Tap **Back** to return to the map.

13. If necessary, tap the map somewhere else to modify the destination. The Cursor () appears at the new location. Tap **Next** to confirm the destination, or tap **Back** to select a different destination.



- After a short summary of the route parameters, the map appears showing the entire route. The route is automatically calculated. Tap  to modify route parameters, or tap  and start your journey.



3.1.2.4 Searching for a Place of Interest by name



You can search for Places of Interest by their names. You can search around different locations or along your route in the whole Place database or in one Place category or subcategory only.

- If you are on the Map screen, tap  to return to the Navigation Menu.

- In the Navigation Menu, tap the following buttons:  .

- Tap .

- Select the area around which the Place should be searched for:

- Tap  to search around the current position or if it is not available, around the last known position. (The result list will be ordered by the distance from this position.)
- Tap  to search for a place within a selected city/town. (The result list will be ordered by the distance from the centre of the selected city/town.)
- Tap  to search for a place around the destination of the active route. (The result list will be ordered by the distance from the destination.)

- Tap **Along Route** to search along the active route, and not around a given point. This is useful when you search for a later stopover that results in a minimal detour only, such as searching for upcoming petrol stations or restaurants. (The result list will be ordered by the length of the necessary detour.)



5. (optional) If you have selected **In a Town**, select the city/town to search in.



6. Select one of the main Place categories (e.g. Accommodation) to search in or tap **Find by Name** to search among all Places.

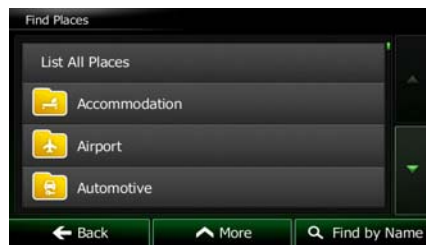

7. Select one of the Place subcategories (e.g. Hotel or Motel) to search in or tap **Find by Name** to search in the selected Place category.

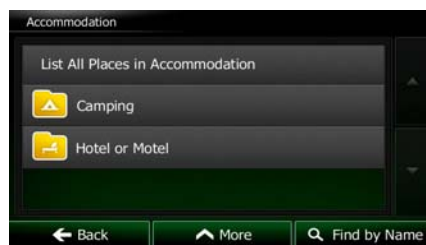

8. Tap  if you have not done it before.

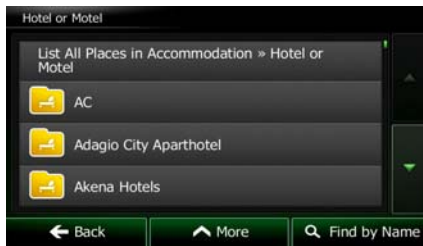

9. Using the keyboard, start entering the name of the Place.







10. After entering a few letters, tap  to open the list of Places with names containing the entered character sequence.





11. (optional) The Places in the list are ordered by their distance from the current or last known position, from the selected city/town, from the destination or by the length of the necessary detour. If you need to reorder the list, tap .

12. Browse the list if necessary and tap one of the list items. A full screen map appears with the selected point in the middle. The name and address of the Place is displayed at the top of the screen.

13. (optional) Tap  to see the details of the selected Place. Tap  to return to the map.

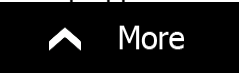
14. If necessary, tap the map somewhere else to modify the destination. The Cursor () appears at the new location. Tap  to confirm the destination, or tap  to select a different destination.



15. After a short summary of the route parameters, the map appears showing the entire route. The route is automatically calculated. Tap  to modify route parameters, or tap  and start your journey.



3.1.2.5 Searching for a Place of Interest by its Phone Number

You can search for Places of Interest by their Phone Number:

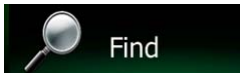
1. If you are on the Map screen, tap  to return to the Navigation Menu.

2. In the Navigation Menu, tap the following buttons:  , .
3. The numeric keyboard appears. Enter the phone number you are looking for or a part of it.

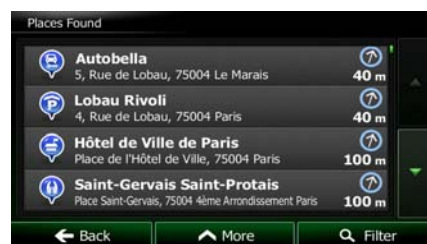

4. Tap .
5. The list of Places with the entered sequence in their phone number appears.







6. (optional) The Places in the list are ordered by their distance from the current or last known position, from the selected city/town, from the destination or by the length of the

necessary detour. If you need to reorder the list, tap .

7. Browse the list if necessary and tap one of the list items. A full screen map appears with the selected point in the middle. The name and address of the Place is displayed at the top of the screen.

8. (optional) Tap  to see the details of the selected Place. Tap  to return to the map.

- If necessary, tap the map somewhere else to modify the destination. The Cursor () appears at the new location. Tap  to confirm the destination, or tap  to select a different destination.
- After a short summary of the route parameters, the map appears showing the entire route. The route is automatically calculated. Tap  to modify route parameters, or tap  and start your journey.



3.1.2.6 Selecting nearby assistance from 'Where Am I?'

You can quickly search for nearby assistance from the 'Where Am I?' screen.

- On the Map screen, tap  to open the Quick menu.



- Tap  , and then  .



- Preset search categories appear, all for searching around the current position (or around the last known position if the current position is not available):

-  Car Repair Around Here : Car repair and roadside assistance services

-  Health Around Here : Medical and emergency services

- : Police stations
- : Petrol stations



4. Tap any of the quick search buttons to get an instant list of that type of Places.



5. (optional) The Places in the list are ordered by their distance from the current or last known position, from the selected city/town, from the destination or by the length of the

necessary detour. If you need to reorder the list, tap .

6. Browse the list if necessary and tap one of the list items. A full screen map appears with the selected point in the middle. The name and address of the Place is displayed at the top of the screen.

7. (optional) Tap  to see the details of the selected Place. Tap  to return to the map.

8. If necessary, tap the map somewhere else to modify the destination. The Cursor

() appears at the new location. Tap  to confirm the destination, or tap  to select a different destination.

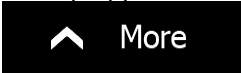
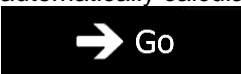
9. After a short summary of the route parameters, the map appears showing the entire route. The route is automatically calculated. Tap  to modify route parameters, or tap  and start your journey.



3.1.3 Selecting a map location as the destination

1. If you are on the Map screen, tap  to return to the Navigation Menu.

2. In the Navigation Menu, tap the following buttons:



3. Locate your destination on the map: move and scale the map as needed.



4. Tap the location that you want to select as your destination. The Cursor () appears.

5. Tap  to select the Cursor as the destination.

6. After a short summary of the route parameters, the map appears showing the entire route. The route is automatically calculated. Tap

the  to modify route

parameters, or tap  and start your journey.



3.1.4 Selecting the destination from your Favourites

You can select a location that you have already saved as a Favourite to be your destination. Adding a location to the list of Favourite destinations is described on page 65.

1. Access the list of Favourites:

- If you are on the Map screen, tap  to open the Quick menu.



- If you are in the Navigation Menu, tap .





2. Tap . The list of Favourite destinations is displayed.





3. Tap the Favourite that you want to set as your destination. If necessary, browse down to see more of the list or tap  and enter a few letters from the name of the Favourite destination.

4. A full screen map appears with the selected point in the middle. If necessary, tap the map somewhere else to modify the destination. The Cursor () appears at the new location. Tap  to confirm the destination, or tap  to select a different destination.

5. After a short summary of the route parameters, the map appears showing the entire route. The route is automatically calculated. Tap  to modify route parameters, or tap  and start your journey.









3.1.5 Selecting your Home location

To navigate to your Home location, first you need to save it. Search for your address or browse the map and when the Cursor is at the desired location, tap  and select .

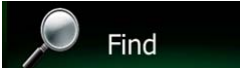
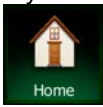
Now that the Home location is set, you can quickly navigate to it:

1. To select the Home location, do one of the following:

- If you are on the Map screen, tap  and then tap  (this button can be added to the Quick menu in Settings - page 82).





- If you are in the Navigation Menu, tap  and then tap .
2. A full screen map appears with the selected point in the middle. If necessary, tap the map somewhere else to modify the destination. The Cursor () appears at the new location. Tap  to confirm the destination, or tap  to select a different destination.
 3. After a short summary of the route parameters, the map appears showing the entire route. The route is automatically calculated. Tap  to modify route parameters, or tap  and start your journey.



3.1.6 Selecting a recent destination from the History

The destinations that you have set earlier appear in the History.

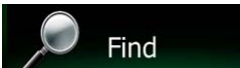
1. Access the History:

- If you are on the Map screen, tap  and then tap .
- If you are in the Navigation Menu, tap  and then tap .

- The list of recent destinations appears. Smart History promotes three destinations to the first page based on your previous routes (most likely destinations). The rest of the destinations are ordered by time they were last selected. If necessary, scroll the list to see earlier destinations.

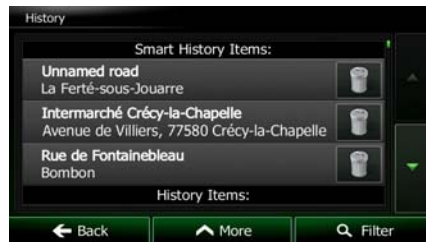



- Select a destination from the list.
- A full screen map appears with the selected point in the middle. If necessary, tap the

map somewhere else to modify the destination. The Cursor () appears at the

new location. Tap  to confirm the destination, or tap

 to select a different destination.

- After a short summary of the route parameters, the map appears showing the entire route. The route is automatically calculated. Tap  to modify route parameters, or tap  and start your journey.



3.1.7 Entering the Coordinate of the destination

You can also select a destination by entering its coordinate. Do as follows:

- If you are on the Map screen, tap  to return to the Navigation Menu.

- In the Navigation Menu, tap .

- Tap .

- You can enter the latitude and longitude values in any of the following formats: decimal degrees; degrees and decimal minutes; or degrees, minutes and decimal seconds.



- (optional) If necessary, tap **More** then **UTM** and enter



- When finished, tap **Done**.
- A full screen map appears with the selected point in the middle. If necessary, tap the







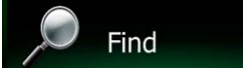

map somewhere else to modify the destination. The Cursor () appears at the new location. Tap **Next** to confirm the destination, or tap **Back** to select a different destination.

- After a short summary of the route parameters, the map appears showing the entire route. The route is automatically calculated. Tap **More** to modify route parameters, or tap **Go** and start your journey.



3.1.8 Navigate to a location stored in a photo

You can also set the location stored in a photo as your destination. Do as follows:

1. If you are on the Map screen, tap  to return to the Navigation Menu.
2. In the Navigation Menu, tap .
3. Open the  menu and tap .
4. The list of photos stored in the device appears. Select one photo from the list.
5. A full screen map appears with the selected point in the middle. If necessary, tap the map somewhere else to modify the destination. The Cursor () appears at the new location. Tap  to confirm the destination, or tap  to select a different destination.
6. After a short summary of the route parameters, the map appears showing the entire route. The route is automatically calculated. Tap  to modify route parameters, or tap  and start your journey.



 **Note!** Only geotagged JPG files contain location information. That is why these kind of files can only be used in navigation. Other picture files do not appear in the list. Files must be located on an inserted SD card or USB pendrive, either in the root folder or in a "pictures" folder.

3.1.9 Building a route from the list of destinations (Create Route)

You can also build your route destination by destination from the My Route menu.

1. If you are on the Map screen, tap  to return to the Navigation Menu.

2. In the Navigation Menu, tap .

3. Tap .

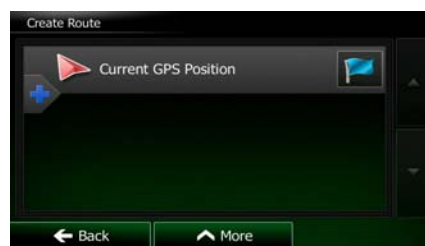

4. There is only one line in the list of route points, the start point of the route, normally the current GPS position.

5. Tap  to select the destination.

6. The Destination menu appears and you can select the destination of the route the same way as described in the previous sections.





7. When the new destination is selected, the list returns.



8. To add more destinations, tap  where you want to insert the new route point in the list, and repeat the above procedure.

3.2 Viewing the entire route on the map

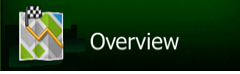

It is easy to get a map overview of the active route. Do as follows:

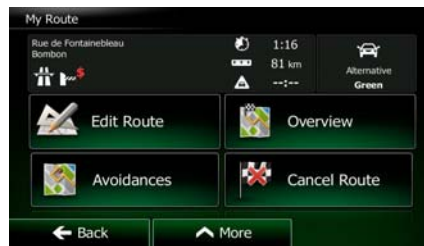
1. If you are on the Map screen, tap  to return to the Navigation Menu.
2. In the Navigation Menu, tap .
3. Tap . The active route is displayed in its full length on the map together with additional information and controls.





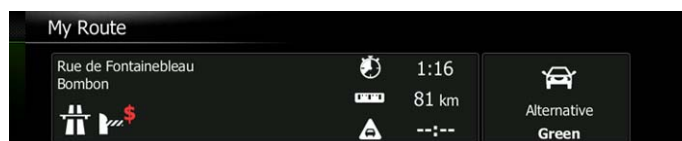

3.3 Checking route parameters and accessing route related functions

You can check different parameters of the route recommended by Clarion Mobile Map.

1. If you are on the Map screen, tap  to return to the Navigation Menu.
2. In the Navigation Menu, tap .
3. The following pieces of information are displayed:
 - The name and/or address of the destination.
 - Warning icons (if any). They provide extra information about your route (e.g. unpaved roads or toll roads to be taken).
 - The total time of the route.
 - The total length of the route.
 - Estimated delay calculated from traffic events on your route.
 - The symbol of the vehicle type used in route calculation.
 - The route planning method (e.g. Fast).

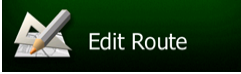
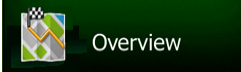

4. You have the following options on this screen (for detailed instructions on how to use them, see the next chapter):

- Tap  to edit the route: to add or remove destinations or change their sequence. You can also set a route start point other than your current location. This can be useful to plan and save a future trip.
- Tap  to display the entire route on the map.
- Tap  to bypass a part of the route.
- Tap  to delete the active route.
- Tap  to open a list with more options like selecting from route alternatives, changing route parameters, simulating the route, saving the active route or loading a previously saved route.
- Tap  to return to the Navigation Menu.

3.4 Modifying the route

When navigation is already started, there are several ways to modify the active route. The following sections show some of those options.

3.4.1 Selecting a new destination when already having a route: New Route, Waypoint or Final Destination

If you already have a recommended route and you select a new destination as described in the above sections, the application will ask you whether to start a new route, add a new waypoint (intermediate destination) to the route or append the newly selected destination at the end of the current route.



- Tap  to plan a new route to the newly selected location. The previous destination and waypoint(s) are deleted.



- Tap  to add the newly selected location as an intermediate destination to your route. The other destinations of the route remain intact. Note: the new waypoint is placed among destinations to keep the route optimal. To decide where a waypoint to appear, use the Edit Route feature.





- Tap  to append the newly selected destination at the end of the route. The other destinations of the route remain intact. The previous final destination is now the last waypoint.

3.4.2 Setting a new starting position for the route

For normal navigation, all routes are planned from the current position. In order to check future routes, simulate them or see their length in time and distance, you can turn off the GPS receiver. Then you can set the starting point of the route to a different location than the current GPS position.

1. If you are on the Map screen, tap  to return to the Navigation Menu.

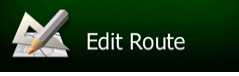
2. In the Navigation Menu, tap .

3. If you already have a route, tap . If you are starting a new route, tap .

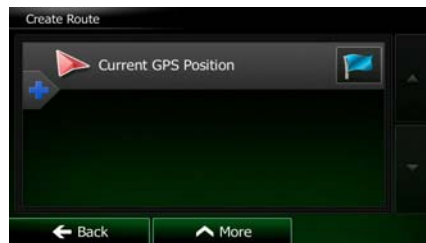

- The first line is the start of the route, normally the current GPS position. Tap  and confirm your action at the warning message.

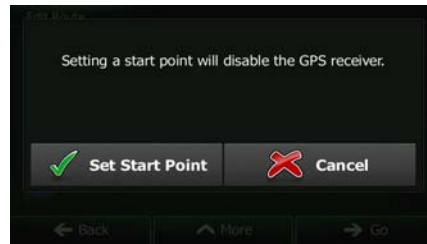

- The Destination menu appears and you can select the start point of the route the same way you select a destination.



- When the new start point is set, tap .
- The map returns with a transparent Vehimarker (showing that there is no GPS reception). If an active route already existed, it is now recalculated starting from the selected location.



- To return to normal navigation, tap .

3.4.3 Editing the list of destinations (Edit Route)

You can edit the route by modifying the list of destinations. You can add or remove destinations, modify the start position or reorder the list.



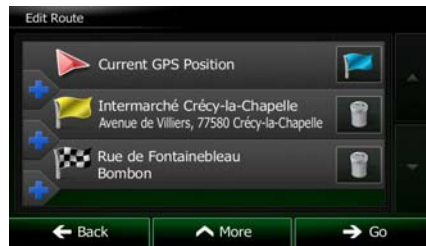

- If you are on the Map screen, tap  to return to the Navigation Menu.

- In the Navigation Menu, tap .

3. Tap .



4. You have the following options:

- Tap  to add a new destination.
- Tap  to delete a destination.
- Tap  to modify the start point of the route.
- Tap  to reorder the list. You can do it manually or you can let the application optimise the route for you.

3.4.4 Pausing the active route

You do not need to pause the active route: when you start driving again, Clarion Mobile Map restarts the voice instructions from your position.

3.4.5 Cancelling the active route

To cancel the navigated route, do one of the following:

- If you are on the Map screen, tap  and then tap . (If you have a route with waypoints, you need to tap  until all waypoints are deleted.)
- In the Navigation Menu, tap  and then tap . The active route is deleted with all its waypoints.

3.4.6 Checking route alternatives when planning the route

You can select from different route alternatives or change the route planning method after you have selected a new destination. Do as follows:

1. Select a destination as explained earlier, and get to the route confirmation screen.



2. Tap

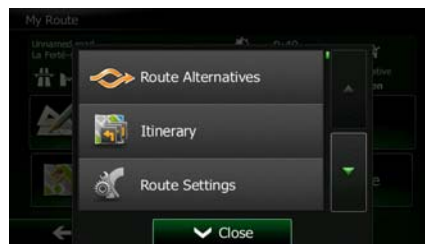

3. Tap



4. You see the basic details of three route alternatives with the selected route planning method. Tap any of them to see it on the map.



5. Or if you cannot find a good alternative, tap



and scroll down for routes with different routing methods.



6. Select one of the route alternatives and tap



to return to the previous screen. Clarion Mobile Map recalculates the route. The orange line now shows the new recommended route.

3.4.7 Checking route alternatives for an existing route

To recalculate the active route with a different route planning method, you can modify the Route settings (page 83). There is another way to do this and to compare different route alternatives with the same route planning method. Do as follows:

1. If you are on the Map screen, tap **Menu** to return to the Navigation Menu.

2. In the Navigation Menu, tap .



3. Tap .

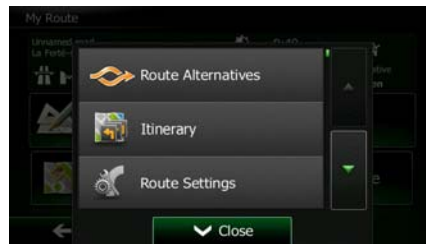

4. Tap .

5. You see the basic details of three route alternatives with the selected route planning method. Tap any of them to see it on the map.





6. Or if you cannot find a good alternative, tap **More Results** and scroll down for routes with different routing methods.





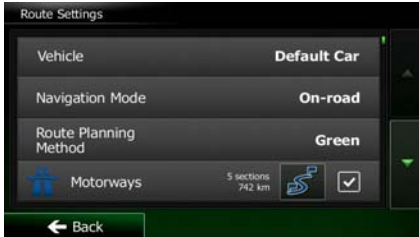

7. Select one of the route alternatives then tap and hold  for a few seconds to return to the Map screen. Clarion Mobile Map recalculates the route. The orange line now shows the new recommended route.

3.4.8 Changing the vehicle used in route planning

To recalculate the active route for a different vehicle, do as follows. These changes can also be made in Settings (page 83).

1. On the Map screen, tap  and then tap .
- 



2. Tap  and then tap one of the following:

-  Default Car
-  Default Emergency
-  Default Bus
-  Default Taxi

3. Clarion Mobile Map recalculates the route optimised for the new vehicle type. The orange line now shows the new recommended route.





3.4.9 Changing the road types used in route planning

To recalculate the active route with different road type preferences, do as follows. These changes can also be made in Settings (page 83).

1. On the Map screen, tap  and then tap .



2. Tap any of the listed road types to modify the route. If needed, scroll the list for all road types. You have the following options (their order depends on the selected vehicle type):

-  **Motorways** - You might need to avoid motorways when you are driving a slow car or you are towing another vehicle.
-  **Period Charge** - Charge roads are pay roads where you can purchase a pass or vignette to use the road for a longer period of time. They can be enabled or disabled separately from toll roads.
-  **Per-use Toll** - Clarion Mobile Map includes toll roads (pay roads where there is a per-use charge) in the routes by default. If you disable toll roads, Clarion Mobile Map plans the best toll-free route.
-  **Ferries** - Clarion Mobile Map includes ferries in a planned route by default. However, a map does not necessarily contain information about the accessibility of temporary ferries. You might also need to pay a fare on ferries.
-  **Unpaved Roads** - Clarion Mobile Map excludes unpaved roads by default: unpaved roads can be in a bad condition and usually you cannot reach the speed limit on them.

3. Tap  to confirm the changes. Clarion Mobile Map recalculates the route. The orange line now shows the new recommended route.

3.5 Saving a location as a Favourite destination

You can add any location to Favourites, the list of frequently used destinations. Planning a route to one of the Favourite destinations is described on page 49.

1. Select a destination as described before. It can be an address, a Place, any location on the map, a previously used destination from History, etc.
2. When the full screen map appears with the selected location in the middle, tap

 More

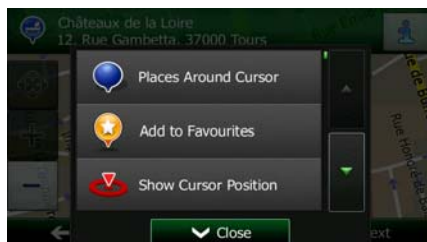

3. Tap  Add to Favourites.
4. (optional) Using the keyboard, you can change the name offered for the Favourite. Tap

123

to enter numbers or symbols.



5. Tap  Done to save the location as a new Favourite destination.

3.6 Saving a location as an alert point

You can save any map location as an alert point (for example a speed camera or a railway crossing).

1. Browse the map and select a location. The red Cursor appears there.

2. Tap .

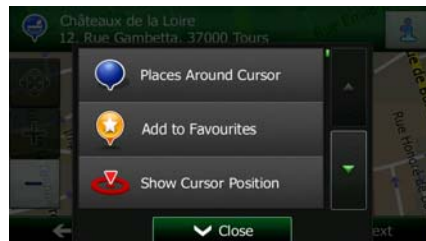

3. Scroll down the list and tap .

4. On the newly opened screen, select the type of the alert point, the direction from which you expect the alert, and (if applicable) the speed limit for this alert point.



5. Tap  to save the location as a new alert point.

3.7 Editing an alert point

You can edit a previously saved or uploaded alert point (for example a speed camera or a railway crossing).

1. Browse the map and select the alert point to edit. The red circle appears around the alert point.

2. Tap .

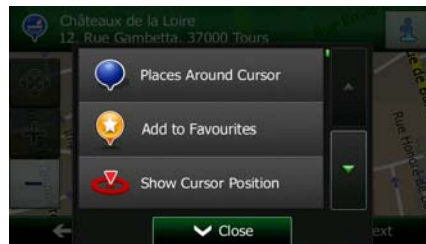

3. Scroll down the list and tap .

4. On the newly opened screen, modify the type of the alert point, the direction from which you expect the alert, or (if applicable) the speed limit for this alert point.



5. Tap  to save the changes to the alert point.

3.8 Watching the simulation of the route

You can run a simulated navigation that demonstrates the active route. Do as follows:

1. If you are on the Map screen, tap  to return to the Navigation Menu.

2. In the Navigation Menu, tap .

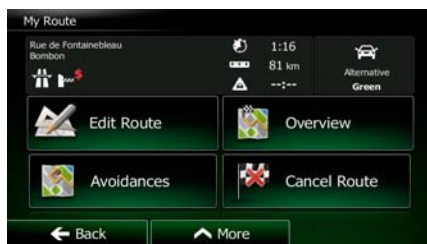



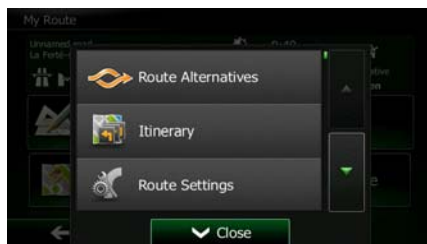

3. Tap .



4. Scroll down the list and tap . The simulation starts from the starting point of the route, and using a realistic speed, it leads you through the whole recommended route.









1. (optional) You have the following controls during the simulation (the control buttons disappear after a few seconds but you can open them again if you tap the map):
 - : Jump to the next route event (manoeuvre).
 - : Pause the simulation.

- : Jump to the previous route event (manoeuvre).
- : Tap to increase the speed of the simulation to 4, 8 or 16 times faster. Now tap again to return to the normal speed.

2. Tap  to stop the simulation.

4 Off-road navigation

When first started, Clarion Mobile Map calculates routes using the road network of the high quality vector maps provided with the product. You can switch the application to off-road mode in Navigation settings in one of the following ways:

- From the Main menu, tap , ,  and then .
- From the Map screen, tap ,  and then .

Most of the procedures described for on-road navigation also apply to off-road navigation. However, there are some that are not available in this navigation mode (for example you cannot open the itinerary as you have no manoeuvres just route points and straight lines between them).

4.1 Selecting the destination of the route

Selecting the start point or a destination (waypoint or final destination) is the same as described at on-road navigation. The only difference is that route points are linked to form a route with straight lines regardless of the road network and traffic regulations.

4.2 Navigating in off-road mode

The real difference between the on-road and off-road modes is the navigation itself. When you are on the Map screen with an off-road route:

- your position and heading is not aligned with the nearest road and
- there is no turn by turn navigation just a recommended direction.

You see a orange line drawn between your current position and the next destination to reach. The Turn Preview field in the top left corner shows a compass with your bearing and the distance of the next destination.

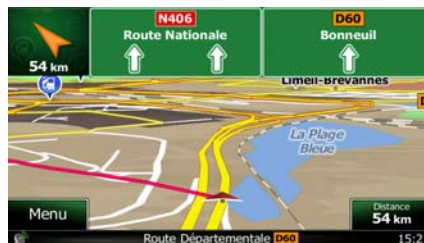

When you reach a waypoint, the orange line will show the direction to the next destination. (Future legs of the route are shown with orange lines.)

When you reach the final destination, navigation ends.

5 Reference Guide

On the following pages you will find the description of the different concepts and menu screens of Clarion Mobile Map.

5.1 Concepts

5.1.1 Smart Zoom

Smart Zoom provides much more than just a usual automatic zoom feature:

- **While following a route:** when approaching a turn, it will zoom in and raise the view angle to let you easily recognise your manoeuvre at the next junction. If the next turn is at a distance, it will zoom out and lower the view angle to be flat so you can see the road in front of you.
- **While driving without an active route:** Smart Zoom will zoom in if you drive slowly and zoom out when you drive at high speed.

5.1.2 Daytime and night colour themes

Clarion Mobile Map uses different colour themes during the day and during the night for both the map and the menu screens.

- Daytime colours are similar to paper road maps, and the menus are bright.
- The night colour themes use dark colours for large objects to keep the average brightness of the screen low.

Clarion Mobile Map offers different daytime and night colour profiles. It can also switch automatically between the daytime and the night schemes based on the current time and GPS position a few minutes before sunrise, when the sky has already turned bright, and a few minutes after sunset, before it becomes dark.

5.1.3 Tunnel view

When entering a tunnel, the map is replaced with a generic tunnel image so that surface roads and buildings cannot distract you.



The top-down overview of the tunnel helps you orientate yourself. The remaining distance in the tunnel is also displayed.





After leaving the tunnel, the original map view returns.

This feature can be turned off in Settings (page 89).

5.1.4 Route calculation and recalculation



Clarion Mobile Map calculates the route based on your preferences:

- Route planning methods:

-  **Fast**: Gives a quick route if you can travel at or near the speed limit on all roads. Usually the best selection for fast and normal cars.
-  **Short**: Gives a route that has the smallest total distance of all possible routes. It can be practical for slow vehicles.
-  **Green**: Gives a quick but fuel efficient route based on the fuel consumption data given in Route settings (page 83). Travel cost and CO₂ emission calculations are estimations only. They cannot take elevations, curves and traffic conditions into account.
-  **Economical**: For vehicle types where Green routing is not available, this method combines the benefits of Fast and Short: Clarion Mobile Map calculates as if it were calculating the Fast route, but it takes other roads as well to save fuel.
-  **Easy**: Results in a route with fewer turns and no difficult manoeuvres. With this option, you can make Clarion Mobile Map to take, for example, the motorway instead of a series of smaller roads or streets.

- Vehicle types:

When creating a new vehicle profile, select one of the below vehicle types. Besides the below mentioned conditions, dimension, weight and freight hazard restrictions can also be taken into account when planning a route.

-  **Default Car**:
 - Manoeuvre restrictions and directional constraints are taken into account when planning a route.
 - Roads are used only if access for cars is allowed.
 - Private roads and resident-only roads are used only if they are inevitable to reach the destination.
 - Walkways are excluded from routes.
-  **Default Emergency**:
 - All manoeuvres are available in intersections.
 - Directional constraints are taken into account the way that opposite direction is allowed with a low speed.
 - A private road is used only if the destination is there.

- Walkways are excluded from routes.

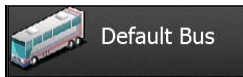

- - Manoeuvre restrictions and directional constraints are taken into account when planning a route.
 - Roads are used only if access for buses is allowed.
 - Private roads, resident-only roads and walkways are excluded from routes.

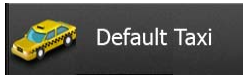

- - Manoeuvre restrictions and directional constraints are taken into account when planning a route.
 - Roads are used only if access for taxis is allowed.
 - Private roads, resident-only roads and walkways are excluded from routes.

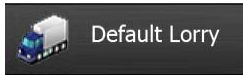

- - Manoeuvre restrictions and directional constraints are taken into account when planning a route.
 - Roads are used only if access for lorries is allowed.
 - Private roads, resident-only roads and walkways are excluded from routes.
 - U-turns are excluded from routes (turning back on a divided road is not considered as a U-turn).

- Road types used or avoided in route calculation:



-



-

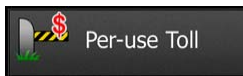

-



-

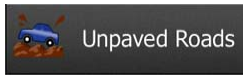

-

Real-time Traffic events are also taken into account and sometimes greatly modify the route. Clarion Mobile Map automatically recalculates the route if you deviate from the proposed itinerary or if a newly received Traffic event concerns a part of the recommended route. For further information about Route settings, see page 83.

5.1.5 Green routing

Route calculation is not only about finding the quickest or shortest route. For some of the vehicle types, you can also check the fuel consumption and CO₂ emission when planning a route, and you can create cost effective routes with less effect on the environment.

In Route settings, you can edit the parameters of the selected vehicle. Enter the fuel consumption values and the price of the fuel. You can also select whether you want to see the difference between your route and the green route even if the selected routing method is not Green.



After the above parameters are set, select **Green** as route planning method to get a fast but also fuel efficient route. Note that travel cost and CO₂ emission calculations are estimations only. They cannot take elevations, turns, curves and traffic conditions into account. Also, this routing is not meant to give you the "greenest" route of all. It is still important to travel quickly so the result is a fast route with low fuel consumption and CO₂ emission.

With a vehicle type where green routing is selectable, whichever route planning method is selected, the Green details are also shown when you confirm the route:



If the selected route planning method is not Green, and you have allowed the application to show the green alternative, the price, fuel consumption and CO₂ emission differences between your selected route and the Green route are also shown on this screen:



Tap the field with these details to switch the route to Green immediately.

5.1.6 Road safety cameras and other proximity alert points

There is a special proximity warning for road safety cameras (like speed or red light cameras) and other proximity alert points (like schools or railroad crossings). These alert points are preloaded in Clarion Mobile Map. You can download more from www.clarion.naviextras.com or you can upload points in a specific text file if needed.

You can also add your own alert points or edit the preloaded or uploaded points. See page 66 for details.

The application can warn you when you approach road safety cameras like speed cameras or dangerous areas like school zones or railroad crossings. You can set up the different alert types individually in Sound and Warning settings (page 80).

The following alert types are available:

- Audio warning: beeps can be played (natural voice) or the type of the alert can be announced (TTS) while you are approaching one of these points, and an extra alert can warn you if you exceed the given speed limit while approaching.
- Visual warning: the type of the alert point, its distance and the related speed limit appear on the Map screen while you are approaching one of these cameras.

For some of the alert points, the enforced or expected speed limit is available. For these points, the audio alert can be different if you are below or above the given speed limit.

- Only when speeding: The audio alert is only played when you exceed the given speed limit.
- When approaching: The audio alert is always played when approaching one of these alert points. In order to draw your attention, the alert can be different when you exceed the speed limit.

 **Note!** The warning for road safety cameras is disabled when you are in a country where road safety camera warning is prohibited. However, you must ensure on your own liability that using this feature is legal in the country where you intend to use it.

5.1.7 Speed limit warning

Maps may contain information about the speed limits of the road segments. Clarion Mobile Map is able to warn you if you exceed the current limit. This information may not be available for your region (ask your local dealer), or may not be fully correct for all roads in the map.

The maximum speed set in the vehicle profile is also used for this warning. Clarion Mobile Map alerts you if you exceed the preset value even if the legal speed limit is higher.

Speed warning can be fine-tuned in Sound and Warning settings (page 80).

You can set the relative speed above which the application initiates the warning.

The following alert types are available:

- Audio warning: you receive a verbal warning when you exceed the speed limit with the given percentage.
- Visual warning: the current speed limit is shown on the map when you exceed it (for example: ).

You can also choose to see the speed limit sign on the map all the time.

5.1.8 Traffic information in route planning

The recommended route is not always the same between two points. Real-time traffic information can help you avoid current traffic events like temporary road closures or a traffic jam caused by an accident. The function is subject to data availability.

You can display the live traffic information on the map if you browse the map and select this option from the More menu. A 2D map is displayed with road segments coloured by the

severity of traffic events. Tap the event type icon at the road segment and then tap the  button to get information about the traffic event.



5.1.8.1 Real-time traffic information (TMC)

TMC (Traffic Message Channel) can provide you with the real-time status of the traffic. Route calculation can avoid road blocks or unexpected traffic jams caused by an accident.

TMC is a specific application of the FM Radio Data System (RDS) used for broadcasting real-time traffic and weather information.

Using traffic information is enabled by default in Clarion Mobile Map.

 **Note!** TMC is not a global service. It may not be available in your country or region. Ask your local dealer for coverage details.

Clarion NX502E contains the TMC receiver that is needed to receive Traffic events.

If public Traffic data is broadcast at your location, Clarion Mobile Map automatically takes into account the traffic events received. You do not need to set anything in the program. The receiver will automatically search the FM radio stations for TMC data, and the decoded information will immediately be used in route planning. When Clarion Mobile Map receives traffic information that may affect your route, the program will warn you that it is recalculating the route, and navigation will continue with a new route that is optimal considering the most up-to-date traffic conditions.

To fine-tune this recalculation, you can set the minimum delay that can trigger a route recalculation, or you can instruct Clarion Mobile Map to have you confirm the new recommended route before it takes effect. You can do these in Traffic settings (page 82).



A special icon () is displayed on the Map screen to show you whether traffic events are received. The icon shows the status of the traffic receiver when there are no traffic events on your route, otherwise it shows the type of the next traffic event on your route.

Road segments affected by traffic events are displayed with an alternate colour on the map, and small symbols above the road show the nature of the event:



Tap  to open the Traffic Summary screen:



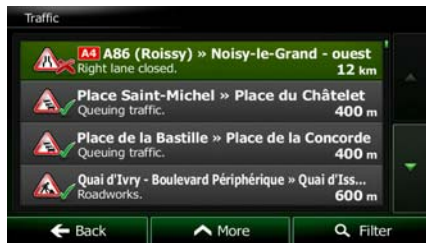

Tap  Event List to open the list of traffic events:



Now tap any of the list items to see its details, and to display the affected road segment in its full length on the map:









 **Note!** If there are traffic events on the recommended route that the application has not bypassed, the  icon will open the list of significant traffic events to let you quickly check them.

5.2 'More' menu

The 'More' menu provides you with various options and additional applications. Tap the

following buttons:

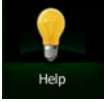

| Button | Description |
|---|---|
|  | <p>You can configure the program settings, and modify the behaviour of Clarion Mobile Map. Fine-tune route planning options, change the look of the Map screen, turn on or off warnings, or restart the Configuration wizard, etc.</p> <p>See the next chapter for details.</p> |
|  | <p>Visit www.clarion.naviextras.com to get additional content, such as new maps or 3D landmarks and useful applications.</p> |
|  | <p>The scientific calculator helps you in all your calculation needs. Tap the Mode button for additional functions and use the memory to save your results.</p> |
|  | <p>The Fuel consumption monitor helps you keep track of the consumption of your car even if you do not use navigation for all your journeys. Set the initial odometer value and then record the distance taken and fuel filled in whenever you fill your car. You can also set reminders for regular car maintenance.</p> |
|  | <p>Tap this button to see the sunlit and dark areas of the world. Your current location and route points are marked on the map. Tap the Details button to see the exact sunrise and sunset times for all your route points (your current location, all waypoints and the final destination).</p> |
|  | <p>If you save your trip logs when you arrive at some of your destinations or let the application automatically save the trip logs for you, those logs are all listed here. Tap one of the trips to see the trip statistics, speed and altitude profile. If track log has also been saved, you can display it on the map with the selected colour. Track logs can be exported to GPX files for later use.</p> |
|  | <p>Select a country from the list and see useful driving information about the selected country. Information may include speed limits on different road types, the maximum blood alcohol level and any compulsory equipment you need to show when stopped by the police.</p> |

| | |
|---|---|
|  | <p>Run the Demo to watch sample route simulations to see how navigation works.</p> <p>The About section provides you with product information. Read the Software and Database End User License Agreement, or check the map and other contents of the application. You can also access program usage statistics.</p> |
|---|---|

5.3 Settings menu





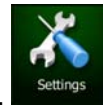

You can configure the program settings, and modify the behaviour of Clarion Mobile Map. Tap

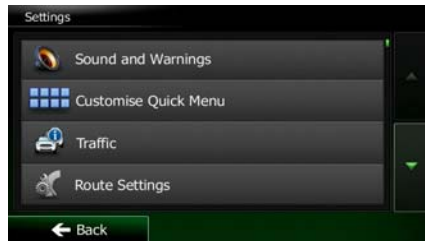





the following buttons:



The Settings menu has several options. Tap  or scroll with your finger to see the full list.





| Button | Description |
|--|--|
|  Sound and Warnings | Adjust the sound volume, mute your device or change the voice guidance language. In addition, you can enable and set up different warnings and alerts. |
|  Customise Quick Menu | The content of the Quick menu (page 21) is fully customisable. Tap the button you want to change, and select its new function from the list. |
|  Traffic | The recommended route is not always the same between two points. Whenever suitable data exists, traffic information can be taken into account in the route calculation. |
|  Route Settings | These settings determine how routes will be calculated. Select the type of vehicle you are driving, the road types used in route planning, and the route planning method. |
|  User Profiles | If more drivers use Clarion Mobile Map for navigating, their settings can be remembered by using one of the user profiles. |
|  Map Settings | You can fine-tune the appearance of the Map screen. Adjust the map view to your needs, choose suitable colour themes from the list for both daytime and night use, change the red arrow to a 3D car model, show or suppress 3D buildings, turn track logging on or off, and manage your Place visibility sets (which Places to show on the map). |

| | |
|--|---|
|  Visual Guidance | Adjust how the software helps you navigate with different kinds of route related information on the Map screen. |
|  Display | Display related settings. |
|  Regional | These settings allow you to customise the application for your local language, measurement units, time and date settings and formats, as well as to choose the time zone. |
|  Trip Monitor | Trip logs and track logs contain useful information about your trips. Trip logs can be saved manually when you reach your destination or you can turn on the automatic saving here. |
|  Start Configuration Wizard | Modify the basic software parameters set during the initial setup process. For details, see page 7. |
|  Reset to Defaults | Delete all saved data and reset all settings to their factory defaults. |

5.3.1 Sound and Warnings

Adjust the different sounds of the application or change the voice guidance language. In addition, you can enable and set up different warnings and alerts.

| Button | Description |
|---|--|
|  | Tap this button to adjust the volume of the different sounds in the application. A new screen shows the different sound types and their controls. See below for details. |
|  | <p>This button shows the current voice guidance profile. By tapping the button, you can select a new profile from the list of available languages and speakers. Tap any of these to hear a sample voice prompt. Just tap  when you have selected the new spoken language.</p> <p>Different voice profiles are capable of different levels of service:</p> <ul style="list-style-type: none"> • Natural Voice: These prerecorded sounds can only tell you basic information about turns and distances. • TTS Voice: These computed voices can tell you complex instructions, they can tell you the street names or read out the system messages for you. |

| | |
|--------------------------------------|---|
| <p>Advanced Settings</p> | <p>Street names sound correctly only if you use a native voice profile for the country. You can decide whether the application</p> <ul style="list-style-type: none"> • tries to read the street names in a foreign country, • use road numbers in your language or • announces the manoeuvre only. <p>You can also decide whether you want an announcement for distance manoeuvres or it is enough to receive the information when the turn is near.</p> |
| <p>Verbosity Level</p> | <p>Tap this button to set the verbosity of the voice instructions: how much they tell and how often they speak.</p> |
| <p>Speed Warning Settings</p> | <p>Maps may contain information about the speed limits of the road segments. Clarion Mobile Map is able to warn you if you exceed the current limit. This information may not be available for your region (ask your local dealer), or may not be fully correct for all roads in the map.</p> <p>The maximum speed set in the vehicle profile is also used for this warning. Clarion Mobile Map alerts you if you exceed the preset value even if the legal speed limit is higher.</p> <p>This setting lets you decide whether you wish to receive visible and/or audible warnings.</p> <p>Adjust the slider to set the relative speed above which the application initiates the warning.</p> <p>The following alert types are available:</p> <ul style="list-style-type: none"> • Audio warning: you receive a verbal warning when you exceed the speed limit with the given percentage. • Visual warning: the current speed limit is shown on the map when you exceed it. <p>If you prefer to see the speed limit sign on the map all the time (normally it is shown only if your speed exceeds it), you can set it here.</p> |

| | |
|------------------------------------|---|
| <p>Alert Point Settings</p> | <p>This feature allows you to receive a warning when approaching a Road Safety Camera or other alert points like school zones or railroad crossings. You must ensure on your own liability that using this feature is legal in the country where you intend to use it.</p> <p>You can set the alert for the different alert point categories individually. The following alert types are available:</p> <ul style="list-style-type: none"> • Audio warning: beeps can be played (natural voice) or the type of the alert can be announced (TTS) while you are approaching one of these points, and an extra alert can warn you if you exceed the given speed limit while approaching. • Visual warning: the type of the alert point, its distance and the related speed limit appear on the Map screen while you are approaching one of these cameras. <p>For some of the alert points, the enforced or expected speed limit is available. For these points, the audio alert can be different if you are below or above the given speed limit.</p> <ul style="list-style-type: none"> • Only when speeding: The audio alert is only played when you exceed the given speed limit. • When approaching: The audio alert is always played when approaching one of these alert points. In order to draw your attention, the alert is different when you exceed the speed limit. |
| <p>Warning Sign Alerts</p> | <p>Maps may contain driver alert information. Tap this button to turn on or off these warnings and to set the distance from the hazard to receive the warning at. These can be set individually for the different warning types.</p> |

5.3.2 Customise Quick menu



The content of the Quick menu (page 21) is fully customisable. Tap the button you want to change, and select its new function from the list.

The list of available functions and their descriptions are on page 21.

5.3.3 Traffic settings



The recommended route is not always the same between two points. Whenever suitable data exists, traffic information can be taken into account in the route calculation.

| Button | Description |
|---|---|
|  | <p>Use this switch to enable or disable the TMC receiver that can receive real-time traffic information. The rest of the buttons below are all related to the TMC function and are available only if the receiver is enabled.</p> |

| | |
|--|---|
|  Detour | <p>This setting determines how Clarion Mobile Map uses the received real-time traffic information in route calculation. When calculating a new route, or when recalculation becomes necessary based on the received Traffic events, Clarion Mobile Map avoids traffic events if it makes sense.</p> <p>You can also set the minimum delay that triggers route recalculation, and you can instruct the application if you want to confirm every recalculation.</p> |
|  Event Types | <p>Tap this button to open the list of traffic event types, and select which events to take into account in route calculation.</p> |

5.3.4 Route settings



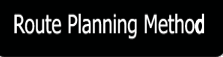
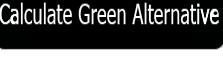

These settings determine how routes will be calculated.

| Button | Description |
|--|---|
|  Vehicle | <p>You can set the type of vehicle you will use to navigate the route. Based upon this setting, some of the road types can be excluded from the route, or some of the restrictions may not be taken into account in route calculation.</p> <p>You can edit the parameters of the selected vehicle profile, or you can even create new vehicle profiles if you tap More.</p> |
|  Navigation Mode | <p>On-road navigation creates a turn by turn itinerary using the road network on the map. Switch to off-road navigation to navigate between destinations in a straight line.</p> |
|  Route Planning Method | <p>The route calculation can be optimised for different situations and vehicle types by changing the planning method. See below for details.</p> |
|  Calculate Green Alternative | <p>If the selected routing method is not Green, you can have your route compared to the best green alternative on the screen when confirming the route. If this alternative is much better than the selected method, you can quickly switch to Green mode.</p> |

To let the route fit your needs, you can also set which road types are to be considered for or to be excluded from the route if possible.

Excluding a road type is a preference. It does not necessarily mean total prohibition. If your destination can only be accessed using some of the excluded road types, they will be used but only as much as necessary. In this case a warning icon will be shown on the My Route screen, and the part of the route not matching your preference will be displayed in a different colour on the map.





In the list of road types you can see in how many segments and what total length of the road type is used in the current route.

| Button | Description |
|---|--|
|  Motorways | You might need to avoid motorways when you are driving a slow car or you are towing another vehicle. |
|  Period Charge | Charge roads are pay roads where you can purchase a pass or vignette to use the road for a longer period of time. They can be enabled or disabled separately from toll roads. |
|  Per-use Toll | Clarion Mobile Map includes toll roads (pay roads where there is a per-use charge) in the routes by default. If you disable toll roads, Clarion Mobile Map plans the best toll-free route. |
|  Ferries | Clarion Mobile Map includes ferries in a planned route by default. However, a map does not necessarily contain information about the accessibility of temporary ferries. You might also need to pay a fare on ferries. |
|  Unpaved Roads | Clarion Mobile Map excludes unpaved roads by default: unpaved roads can be in a bad condition and usually you cannot reach the speed limit on them. |

Vehicle profiles:

Vehicle

When you first tap , you see the list of default vehicle profiles. You have the following options:

| Button | Description |
|--|--|
|  | You can edit the parameters of the vehicle profile. |
|  More | Tap this button to reveal the below options. |
|  Add Profile | Tap this button to create your own vehicle profile. |
|  Restore All Profiles | Tap this button to reset all vehicle profiles to their default settings. |

When creating a new vehicle profile, first you need to select the vehicle type. Then you need to set the following parameters (some of them may not exist for the selected vehicle type). You can modify the same parameters when you edit an existing profile:





| Button | Description |
|------------------------|--|
| Name | Tap this button to rename the profile for something meaningful. |
| Fuel Consumption Urban | Enter the average consumption of your vehicle when used in built-up areas. The unit for consumption can be set in Regional Settings. |

| | |
|------------------------|--|
| Fuel Consumption Rural | Enter the average consumption of your vehicle when used on highways. The unit for consumption can be set in Regional Settings. |
| Type of Engine | Select the engine and fuel type of your vehicle. This helps in estimating the CO ₂ emission. |
| Price of Fuel | Enter the average fuel price for travel cost calculation. The currency can be set in Regional Settings. |
| Max. Speed | Set the maximum speed you travel with the vehicle. |
| Use Extended Settings | Check this box to enable more settings for the below parameters. |
| Length | Set the total length of the vehicle. |
| Width | Set the width of the vehicle. |
| Height | Set the height of the vehicle. |
| Trailer | Set if there is a trailer attached to the vehicle. |
| Maximum Allowed Weight | Set the maximum allowed weight of the vehicle. |
| Actual Weight | Set the actual weight of the vehicle. |
| Freight | Select one or more hazard types if the vehicle carries dangerous material. |



Vehicle types:

When creating a new vehicle profile, select one of the below vehicle types. Besides the below mentioned conditions, dimension, weight and freight hazard restrictions can also be taken into account when planning a route.

-  Default Car:
 - Manoeuvre restrictions and directional constraints are taken into account when planning a route.
 - Roads are used only if access for cars is allowed.
 - Private roads and resident-only roads are used only they are inevitable to reach the destination.
 - Walkways are excluded from routes.

-  Default Emergency :
 - All manoeuvres are available in intersections.
 - Directional constraints are taken into account the way that opposite direction is allowed with a low speed.
 - A private road is used only if the destination is there.
 - Walkways are excluded from routes.
-  Default Bus :
 - Manoeuvre restrictions and directional constraints are taken into account when planning a route.
 - Roads are used only if access for buses is allowed.
 - Private roads, resident-only roads and walkways are excluded from routes.
-  Default Taxi :
 - Manoeuvre restrictions and directional constraints are taken into account when planning a route.
 - Roads are used only if access for taxis is allowed.
 - Private roads, resident-only roads and walkways are excluded from routes.
-  Default Lorry :
 - Manoeuvre restrictions and directional constraints are taken into account when planning a route.
 - Roads are used only if access for lorries is allowed.
 - Private roads, resident-only roads and walkways are excluded from routes.
 - U-turns are excluded from routes (turning back on a divided road is not considered as a U-turn).

Route Planning Method types:

| Button | Description |
|---|--|
|  | Gives a quick route if you can travel at or near the speed limit on all roads. Usually the best selection for fast and normal cars. |
|  | Gives a short route to minimise the distance to travel. It can be practical for slow vehicles. Searching for a short route regardless of the speed, this route type is rarely practical for normal vehicles. |

| | |
|--------------------------|---|
| <p>Green</p> | <p>Gives a quick but fuel efficient route based on the fuel consumption data given in Route settings (page 83). Travel cost and CO₂ emission calculations are estimations only. They cannot take elevations, curves and traffic conditions into account.</p> |
| <p>Economical</p> | <p>For vehicle types where Green routing is not available, this method combines the benefits of Fast and Short: Clarion Mobile Map calculates as if it were calculating the Fast route, but it takes other roads as well to save fuel.</p> |
| <p>Easy</p> | <p>Results in a route with fewer turns and no difficult manoeuvres. With this option, you can make Clarion Mobile Map to take, for example, the motorway instead of a series of smaller roads or streets.</p> |

5.3.5 User profiles

If more drivers use Clarion Mobile Map for navigating, their settings can be remembered by using one of the user profiles. Rename the profiles after tapping the edit button on the right so that all users know which profile to use and switch between profiles by tapping its name. If you select a new profile, the application restarts so that the new settings can take effect.















5.3.6 Map settings

You can fine-tune the appearance of the Map screen. Adjust the map view to your needs, choose suitable colour themes from the list for both daytime and night use, change the red arrow to a 3D car model, show or hide 3D buildings, turn track logging on or off, and manage your Place visibility sets (which Places to show on the map).



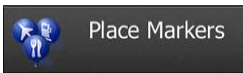





The map is always shown on the screen so that you can see the effect when you change a setting.





| Button | Description |
|---|--|
|  | Switch the map view between a 3D perspective view and a 2D top-down view. |
|  | Adjust the basic zoom and tilt levels to your needs. Three levels are available. |
|  | When selected, the map zooms out to show an overview of the surrounding area if the next route event (manoeuvre) is far. When you get close to the event, the normal map view returns. |
|  | Switch between daytime and night colour modes or let the software switch between the two modes automatically a few minutes before sunrise and a few minutes after sunset. |
|  | Select the colour scheme used in daytime mode. |
|  | Select the colour scheme used in night mode. |
|  | Replace the default position marker to one of the 3D vehicle models. You can select separate icons for different vehicle types selected for route planning. Separate icons can be used for car, pedestrian and the other vehicles. |
|  | Show or suppress 3D landmarks, 3D artistic or block representations of prominent or well-known objects. |
|  | Show or suppress 3D city models, 3D artistic or block representation of full city building data containing actual building size and position on the map. |
|  | Show or suppress the 3D elevation of the surrounding terrain. |
|  | Turn on or off track log saving, that is, saving the sequence of the locations your journeys go through. |
|  | <p>Select which Places to show on the map while navigating. Too many Places make the map crowded so it is a good idea to keep as few of them on the map as possible. For this, you have the possibility to save different Place visibility sets. You have the following possibilities:</p> <ul style="list-style-type: none"> • Tap the checkbox to show or hide the Place category. • Tap the name of the Place category to open the list of its subcategories. • Tap  to save the current Place visibility set or to load a previously saved one. Here you can also revert to the default visibility settings. |

5.3.7 Visual guidance settings

Adjust how the software helps you navigate with different kinds of route related information on the Map screen.

| | |
|---|---|
|  <p>Data Fields</p> | <p>The data fields in the corner of the Map screen can be customised. Tap this button and select the values you want to see. The values can be different when you navigate a route from when you are just cruising without a given destination. You can select general trip data like your current speed or the altitude, or route data related to your final destination or the next waypoint on your route.</p> |
|  <p>Offer Motorway Services</p> | <p>You may need a petrol station or a restaurant during your journey. This feature displays a new button on the map when you are driving on motorways. Tap this button to open a panel with the details of the next few exits or service stations. Tap any of them to display it on the map and add it as a waypoint to your route if needed.</p> |
|  <p>Facility Types</p> | <p>Select the service types displayed for the motorway exists. Choose from the POI categories.</p> |
|  <p>Signpost</p> | <p>Whenever adequate information is available, lane information similar to the real ones on road signs above the road is displayed at the top of the map. You can turn this feature on or off.</p> |
|  <p>Junction View</p> | <p>If you are approaching a motorway exit or a complex intersection and the needed information exists, the map is replaced with a 3D view of the junction. You can turn this feature on or let the map be displayed for the whole route.</p> |
|  <p>Tunnel View</p> | <p>When entering tunnels, the surface roads and buildings can be disturbing. This feature shows a generic picture of a tunnel instead of the map. A top-down overview of the tunnel and remaining distance are also displayed.</p> |
|  <p>Route Progress Bar</p> | <p>Turn on the route progress bar to see your route as a straight line on the left side of the map. The red arrow represents your current position and moves up as you travel. Waypoints and Traffic events are also displayed on the line.</p> |
|  <p>Offer Cong Detour on Motorways</p> | <p>When you slow down while driving on a motorway, there is a chance that you are in a traffic jam so Clarion Mobile Map offers you a detour using the next exit. The message shows you distance of the exit and the difference in distance and estimated time compared to the original route. You can choose from one of the following options:</p> <ul style="list-style-type: none"> • Tap Dismiss or just ignore the message if you want to keep the original route. • Tap Preview to see the overview of the original route and the detour to make the decision. You can accept the detour as offered or increase the bypassed motorway segment before accepting. • Turn to the suggested new direction and the route will be automatically recalculated. |

| | |
|--|--|
|  Offer Real-time Route Alternatives | <p>Similar to the above possibility, alternative routes can be suggested when driving on normal roads. Clarion Mobile Map will select a different turn in the upcoming intersection and offers you a different route for the next section of the route.</p> <p>Your options are the similar as above but you cannot modify the offered detour.</p> |
|  Offer Parking Around Destination | <p>Parking at the destination may not be easy in city areas. As you approach the destination, Clarion Mobile Map can offer parking category Places near your destination. Tap the "P" button to open a top-down map with the destination and the offered parking Places. Select one and modify the route accordingly.</p> |
|  Offer Hints Upon Detour | <p>If you leave the recommended route and suddenly exit the motorway, the application offers different alternatives near the exit like petrol stations or restaurants. Also, if there are avoidable parts of the original route ahead (like a tunnel, a toll road or a ferry), you will find them in the list in case you want to bypass them with the help of Clarion Mobile Map.</p> |



5.3.8 Display settings

Display related settings include menu animations, separate skins for daytime and night use and the brightness of the display.

| | |
|---|--|
|  Menu Animations | <p>When animation is turned on, buttons on menus and keyboard screens appear in an animated way. Screen transitions are also animated.</p> |
|---|--|

5.3.9 Regional settings

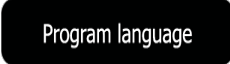
These settings allow you to customise the application for your local language, measurement units, time and date settings and formats, as well as to choose the time zone.

| Button | Description |
|---|---|
|  Program language | <p>This button displays the current written language of the user interface. By tapping the button, you can select a new language from the list of available languages. The application will restart if you change this setting; you are asked to confirm this.</p> |
|  Units and Formats | <p>You can set the distance units to be used by the program. Clarion Mobile Map may not support all the listed units in some voice guidance languages.</p> <p>Select between 12 and 24 hours time display and the various international date display formats.</p> <p>You can also set other country specific units used to display different values in the application.</p> |

| | |
|-----------|---|
| Time Zone | By default, time zone is taken from the map information and adjusted by your current location. Here you can set time zone and daylight saving manually. |
|-----------|---|

5.3.10 Trip monitor settings

Trip logs contain useful information about your trips. Trip logs can be saved manually when you reach your destination or you can turn on the automatic saving here. You can access these logs in the Trip monitor. Trip monitor is available from the More menu.

| | |
|--------------------|---|
| Enable auto-saving | Trip monitor can record statistical data of your trips. If you need these logs later, you can let the application save them automatically for you. |
| Trip database size | This is not a button. This line shows the current size of the trip database, the sum of all trip and track logs saved. |
| Save track log | Track logs, the sequence of the positions given by the GPS receiver, can be saved together with trip logs. They can later be displayed on the map. You can let the application save the track log whenever it saves a trip. |

6 Glossary

2D/3D GPS reception

The GPS receiver uses satellite signals to calculate its (your) position and needs at least four signals to give a three-dimensional position, including elevation. Because the satellites are moving and because objects can block the signals, your GPS device might not receive four signals. If three satellites are available, the receiver can calculate the horizontal GPS position but the accuracy is lower and the GPS device does not give you elevation data: only 2D reception is possible.

Active route

The currently navigated route. Whenever the destination is set, the route is active until you delete it, reach your destination or you quit Clarion Mobile Map. See also: Route.

City Centre

The city/town centre is not the geometric centre of the city/town but an arbitrary point the map creators have chosen. In towns and villages, it is usually the most important intersection; in larger cities, it is one of the important intersections.

Colour theme

Clarion Mobile Map comes with different colour themes for daytime or night use of the map and menu screens. Themes are custom graphic settings and they can have different colours for streets, blocks or surface waters in 2D and 3D modes, and they display shades or shadows in different ways in 3D mode.

One daytime scheme and one night scheme is always selected for the map and for the menus. Clarion Mobile Map uses them when it switches from day to night and back.

GPS accuracy

Several factors have impact on the deviation between your real position and the one given by the GPS device. For example, signal delay in the ionosphere or reflecting objects near the GPS device have a different and varying impact on how accurately the GPS device can calculate your position.

Map

Clarion Mobile Map works with digital maps which are not simply the computerised versions of traditional paper maps. Similarly to the paper road maps, the 2D mode of digital maps show you streets, roads, and elevation is also shown by colours.

In 3D mode, you can see the altitude differences, for example valleys and mountains, elevated roads, and in selected cities 3D landmarks and 3D buildings are also displayed.

You can use digital maps interactively: you can zoom in and out (increase or decrease the scale), you can tilt them up and down, and rotate them left and right. In GPS-supported navigation, digital maps facilitate route planning.

North-up map orientation

In North-up mode the map is rotated so its top always faces North. This is the orientation for example in Find on Map.

Road Safety Camera

Special alert points for speed, red light or bus lane cameras. Different data sources are available. You can configure Clarion Mobile Map to warn you when you approach one of these cameras.

Detecting the location of Road Safety Cameras is prohibited in certain countries. It is the sole responsibility of the driver to check whether this feature can be used during the trip.

The software is capable of showing and warning for more than just cameras. Various other types of proximity alert points like school zones and railway crossings are also available.

Route

A sequence of route events, i.e. manoeuvres (for example, turns and roundabouts) to reach the destination. The route contains one start point and one or more destinations. The start point is the current (or last known) position by default. If you need to see a future route, the start point can be replaced with any other given point.

Track-up map orientation

In Track-up mode the map is rotated so its top always points in the current driving direction. This is the default orientation in 3D map view mode.

Vehimarker

The current position is shown with a red arrow on the map by default. The direction of the red arrow shows the current heading. This position marker can be replaced with different 3D vehicle symbols. You can even specify different Vehimarkers for different route types (depending on which vehicle type is selected for route calculation).

7 End User Licence Agreement

1 The contracting parties

1.1 This Agreement has been entered into by and between NNG Software Developing and Commercial Ltd. (registered seat: 23 Bérc utca, H-1016 Budapest, Hungary; company reg.no.: 01-09-891838) as Licensor (hereinafter: Licensor) and You as the end user (hereinafter: User; the User and the Licensor jointly referred to as: Parties) in subject of the use of the products specified in this Agreement, including software products, databases and content .

2 Conclusion of the Agreement

2.1 The Parties hereby acknowledge that this Agreement shall be concluded by implicit conduct of the Parties without signing the Agreement.

2.2 The User hereby acknowledges that following the lawful acquisition (online purchase from authorized vendor or preinstalled on purchased Device) of the software product constituting the object of this Agreement (Section 4), any degree of use, installation into a computer or other hardware equipment (mobile phone, multi-function device, personal navigation device, in-car navigation or multi function head unit, etc.) (hereinafter referred to as: "Device"), installation of such Device into a vehicle, pressing of the "Accept" button displayed by the software during installation or use (hereinafter referred to as: "Use") shall mean that the User has accepted the terms and conditions of this Agreement as legally binding. The time of conclusion of the present Agreement is the time of executing the first action of use (commencement of use).

2.3 This Agreement shall by no means authorize Use of the software product by those persons having unlawfully acquired the software product or having unlawfully installed it on a Device or in a vehicle.

2.4 U.S. Government Users. If you acquire the Software Product by or on behalf of the United States Government or any other entity seeking or applying rights similar to those customarily claimed by the United States Government, you are on notice that the Software Product and the Databases, content and services are commercial items as that term is defined at 48 C.F.R ("FAR") 2.101 and that all use of the Software Product is subject to this Agreement.

3 Applicable laws and regulations

3.1 Any action related to this Agreement will be governed by the laws of the Republic of Hungary, with specific reference to Act IV of 1959 on the Civil Code and to Act LXXVI of 1999 on Copyrights (the "Copyright Act") shall apply. The United Nations Convention on Contracts for the International Sales of Goods is hereby excluded from application to this EULA.

3.2 The parties hereby agree that the courts of the Republic of Hungary will have exclusive jurisdiction to rule on any disputes arising in connection with this Agreement.

3.3 The original language version of this Agreement is the Hungarian version. This Agreement has versions in other languages as well. In case of dispute the Hungarian version shall prevail.

4 Object of the Agreement and Termination

4.1 The object of this Agreement shall be the navigation guidance software product of Licensor (hereinafter referred to as: the "Software Product").

4.2 The Software Product shall include the operating computer program, its complete documentation, the map database pertaining thereto and any third-party contents and services accessible through the Software Product (hereinafter together referred to as: the "Database").

4.3 Any form of display, storage, coding, including printed, electronic or graphic display, storage, source or object code, or any other as yet undefined form of display, storage, or coding, or any medium thereof shall be deemed parts of the Software Product.

4.4 Error corrections, additions, updates or upgrades to the Software Product or the Databases used by the User following the conclusion of this Agreement shall also be deemed parts of the Software Product and Used in accordance with this Agreement.

4.5. Your rights under this Agreement will terminate immediately without notice from Licensor if you materially breach it or take any action in derogation of Licensor's and/or its licensors' rights to the Software Product. Licensor may terminate this Agreement if any Software Product becomes, or in Licensor's reasonable opinion likely to become, the subject of a claim of intellectual property infringement or trade secret misappropriation. Upon termination, you will cease use of, and destroy Software Product and all parts of it and confirm compliance in writing to Licensor, if requested.

5 Rights under copyright

5.1 Unless otherwise provided by law or contractual provisions, the Licensor is the sole and exclusive owner of all material copyrights vested in the Software Product.

5.2 Copyrights extend to the whole Software Product and to its parts separately as well.

5.3 The owner(s) of the copyrights of the Database or certain works protected by intellectual property rights, that are forming part of the Software Product is (are) the Licensor, or natural person(s) or corporate entity(ies) owners of certain Databases (hereinafter referred to as: "Database Owner"). Some Database Owners are listed in the "About" or similar menu item of the Software Product. The Licensor hereby states that it has obtained sufficient usage and representation rights from the Database Owners in order to utilize the Database, to offer it for utilization and to transfer it for utilization as set forth in this Agreement.

5.4 Pursuant to this Agreement, all rights vested in the Software Product shall remain in the ownership of the Licensor, except for those to which the User is entitled under law or by virtue of this Agreement.

6 Rights of the User

6.1 By default the User is entitled to install the Software Product on one Device having a single GPS sensor built in, and to run and use one copy of the Software Product or a preinstalled copy of the Software Product thereon. The Software Product and Database is for the User's personal or internal business use only.

6.2 The User is entitled to make one backup copy of the Software Product. However, if the Software Product operates after installation without the use of the original media copy, then the original media copy shall be deemed to be a backup copy. In all other cases, the User is only entitled to use the backup copy if the original media copy of the Software Product has been ascertainably and unequivocally rendered unsuitable for its lawful and intended use.

6.3 In the event that the Software Product comes preinstalled on- or otherwise licensed together with the Device or purchased online for and installed by the User for a specific Device, the Software Product shall be tied to the Device and may not be separated-, transferred to-, or used with another Device or sold to another User without selling the Device itself.

6.4 The Database, content or services provided to User may only be used together with User's copy of the Software Product and may not be used separately or with another copy of the Software Product.

7 Limitations of use

7.1 The User is not entitled

7.1.1 to duplicate the Software Product (to make a copy thereof) except to the extent allowed by this Agreement or Applicable law;

7.1.2 to resell, sublicense or use it for commercial purposes, use to lease, rent or lend it, or to transfer it to a third person for any reason without transferring the Device on which it was first legally installed on (see section 6.3);

7.1.3 to translate the Software Product (including translation (compilation) to other programming languages);

7.1.4 to decompile, disassemble, or reverse engineer the Software Product;

7.1.5 to evade the protection of the Software Product or to modify, circumvent or obviate such protection through technological or by any other means;

7.1.6 to modify, extend, transform the Software Product (in whole or in part), to separate it into parts, combine it with other products, install it in other products, utilize it in other products, not even for the purpose of achieving interoperability with other devices;

7.1.7 apart from using the computer program, to obtain information from the Database as a part of the Software Product, to decompile the Database, to use, copy, modify, extend, transform the Database in whole or in part or the group of data stored therein, or to install it in other products or otherwise, utilize it in other products or to transfer it, not even with the aim of achieving interoperability with other products.

7.2 The User may only use the Databases, content and services available through the Software Product and provided by third parties and the data received through the services provided by third parties (including but not limited to the traffic data received from the RDS TMC or on-line TMC traffic information service) for his/her own personal benefit and at his/her own risk. It is strictly prohibited to store, to transfer or to distribute these data or contents or to disclose them in full or in part to the public in any format or to download them from the product.

7.3 The User is not entitled to remove, modify or obscure of any copyright, trademark notice, or restrictive legend included in the Software Product, the Database, content or services.

8 No warranty, limitation of liability

8.1 The Licensor hereby informs the User that although the greatest care was taken in producing the Software Product, given the nature of the Software Product and its technical limitations, the Licensor does not provide a warranty for the Software Product being completely error-free, and the Licensor is not bound by any contractual obligation whereby the Software Product obtained by the User should be completely error-free.

8.2 THE LICENSED SOFTWARE PRODUCTS, DATABASES, CONTENT AND SERVICES ARE PROVIDED ON AN "AS IS" AND "WITH ALL FAULTS BASIS" (INCLUDING NO WARRANTY FOR THE CORRECTION OF FAULTS) AND LICENSOR, THE DATABASE OWNERS AND THIRD PARTY SUPPLIERS EXPRESSLY DISCLAIM ALL WARRANTIES, EXPRESS OR IMPLIED, INCLUDING BUT NOT LIMITED TO, THE IMPLIED WARRANTIES OF NON-INFRINGEMENT, MERCHANTABILITY, SATISFACTORY QUALITY, ACCURACY, TITLE AND FITNESS FOR A PARTICULAR PURPOSE. NO ORAL OR WRITTEN ADVICE OR INFORMATION PROVIDED BY LICENSOR OR ANY OF ITS AGENTS, DATABASE OWNERS, EMPLOYEES OR THIRD PARTY PROVIDERS SHALL CREATE A WARRANTY, AND USER IS NOT ENTITLED TO RELY ON ANY SUCH ADVICE OR INFORMATION. THIS DISCLAIMER OF WARRANTIES IS AN ESSENTIAL CONDITION OF THE AGREEMENT.

Licensor does not warrant that the Software Product, Database, content or service are capable of interoperating with any other system, Device or product (e.g. software or hardware).

8.3 The Licensor does not assume any responsibility for damages incurred due to an error in the Software Product (including errors of the computer program, the documentation and the Database).

8.4 The Licensor does not assume any responsibility for damages incurred due to the Software Product not being applicable for any defined purpose, or due to the error or incompatibility of the Software Product with any other system, device or product (e.g. software or hardware).

8.5 NEITHER LICENSOR NOR ITS SUPPLIERS SHALL BE LIABLE TO USER FOR ANY INCIDENTAL, CONSEQUENTIAL, SPECIAL, INDIRECT OR EXEMPLARY DAMAGES ARISING OUT OF THIS AGREEMENT, INCLUDING LOST PROFITS OR COSTS OF COVER, LOSS OF USE OR BUSINESS INTERRUPTION OR THE LIKE, REGARDLESS OF WHETHER THE PARTY WAS ADVISED OF THE POSSIBILITY OF SUCH DAMAGES.

NOTWITHSTANDING ANYTHING TO THE CONTRARY CONTAINED HEREIN, THIRD PARTY SUPPLIERS (E.G. DATABASE OWNERS, MAP PROVIDERS) OR AGENTS OF LICENSOR SHALL HAVE NO MONETARY LIABILITY TO THE USER FOR ANY CAUSE (REGARDLESS OF THE FORM OF ACTION) UNDER OR RELATING TO THIS AGREEMENT.

8.6 The Licensor also draws the attention of the User to the fact that, when using the Software Product in any form of vehicle, observing the traffic regulations and rules (e.g. use of obligatory and/or reasonable and suitable security measures, proper and generally expected care and attention in the given situation, and special care and attention required due to the use of the Software Product) is the exclusive responsibility of the User. The Licensor shall not assume any responsibility for any damages occurred in relation to use of the Software Product in a motor vehicle.

8.7 By concluding the Agreement, the User shall, in particular, acknowledge the information stated in Section 8 above.

9 Sanctions

9.1 The Licensor hereby informs the User that, if the Licensor finds its rights under the Copyright Act to be breached, the Licensor may

9.1.1 seek judicial recognition of this breach;

9.1.2 demand that the breach cease and order the person in breach to refrain from continuing such actions;

9.1.3 demand that the person under breach give proper compensation (even by way of publicity at the expense of the person in breach);

9.1.4 claim the return of the increase of assets due to the breach;

9.1.5 demand the cease of the wrongful action and, demand restitution to its state before the breach was committed at the expense of the person in breach, and may demand the destruction of instruments and materials used to commit the breach as well as of the products created by the breach;

9.1.6 claim for damages.

9.2 The Licensor hereby also informs the User that the breach of copyrights and related rights is a crime under Act IV of 1978 on the Hungarian Criminal Code, which may be sentenced of two years in prison in basic cases and up to eight years in prison in aggravated cases.

9.3 Content and services provided by third parties. The Licensor hereby excludes any liability of its own for the Database in the Software Product and for any content or service provided by a third party by using the Database. The Licensor does not warrant the quality, suitability, accuracy, fitness for a specific purpose or territorial coverage of the Database, content, product or service or the availability of the Database, content, product or service, and it specifically excludes any liability for the suspension or cancellation of the service, and any damage arising in relation to the service or for complete cancellation of the service. User acknowledges that the mapping data in Databases contains geographical data and other data.

The User hereby acknowledges that (i) inaccurate or incomplete information due to the passage of time, changing circumstances, sources used and the nature of collecting comprehensive geographic data, may each lead to incorrect results; and (ii) that the Database, contents and services provided by third parties may only be used at the risk of the User and for the personal or internal business benefit of the User. User acknowledges that the Databases, content and services are the confidential information of Database Owners and disclosure of the Databases to third parties is prohibited.

USE OF THE SOFTWARE PRODUCT'S REAL TIME ROUTE GUIDANCE FUNCTION IS AT USER'S SOLE RISK AS LOCATION DATA MAY NOT BE ACCURATE.

9.4 Content and services provided by the Licensor or an agent of the Licensor. For certain Software Products the Licensor or a contractual partner may offer various products and services to the User through www.naviextras.com. The User may only use these services when the User has read and understood the relevant end user license agreement(s) at www.naviextras.com and the User is obliged to use the services in line with the terms and conditions thereof.

9.5 Purchase and acquisition of activation license for the use of certain functions, Databases, content or services may require Internet connection with no alternative way of acquisition offered by Licensor.

10 Anonymous data collection

10.1 The User hereby acknowledges that the Software Product may collect, transmit to Licensor or third parties, and in some cases store data connected to the usage of the Software Product by the User (e.g. movement/route data, user interaction data). Such data collection functions may be disabled or enabled by User any time from within the corresponding menu. The collected data is always anonymous, not associated in any way with any personal information of the User or with the User itself.

10.2 The collected data may be uploaded to Licensor's database or transmitted periodically or in real time to a third party partner and used exclusively for the purpose of enhancing and improving the precision and reliability of features and services of the Software Product and the Databases. Uploading is executed through Licensor's special software or by the User navigation device, and the upload may be enabled or disabled by User. After successful data upload, the collected data is deleted from the Software Product storage media.

10.3 Collected data is transmitted, stored and handled anonymously and no connection of the data with the User shall be established by Licensor or any third party.

10.4 Licensor hereby informs the User, that if it accesses the Internet through mobile data service while abroad or otherwise roaming another mobile network the transmission of such data may result in special roaming charges. To avoid such charges it is the responsibility of the User to disable mobile data services while roaming or to turn off the data collection functions of the Software Product.

11 Online Content Service Auxiliary Terms

11.1 For online content services the following auxiliary terms shall also apply. Database content (e.g. weather-, traffic info, location based info) may be supplied by Licensor to the User's Device through an Internet connection (hereinafter: "Online Content Services"). Such Content may be granted for a fee or free of charge subject to Licensor's decision. Ensuring access to the Internet is the responsibility of the User.

11.2 Online Content Services in general are not available in all countries, furthermore different conditions and Service characteristics may apply in different countries. Use of certain Online Services may be prohibited in various countries. It is the User's responsibility to comply with country specific regulation. Licensor excludes its liability for the consequences of illegal use of such functions and User shall indemnify and hold Licensor harmless from all claims against Licensor from authorities or third parties due to the illegal use.

11.3 Online Content is downloaded by the Software Product from Service Provider's Online content servers. The Licensor hereby excludes any liability of its own for the Online content. The Licensor does not warrant the quality, suitability, accuracy, fitness for a specific purpose or territorial coverage of the Online content, furthermore no warranty is offered regarding the availability (e.g. uptime) of Online content servers. User acknowledges that in any territory or time, slow- or non-connectivity may be experienced due to capacity limitations of Licensor's servers. The Software Product may allow the User to access and communicate third party servers directly. In such cases use of such servers is for User's own risk entirely. Licensor shall not undertake any liability whatsoever for such servers and services accessed and received directly from third parties.

11.4 User acknowledges that the data or information provided through Online Content Services is not updated in real-time and may not accurately reflect the real life situation or events.

11.5 The User hereby acknowledges that the Online Content Services may only be used at the risk of the User and for the personal benefit of the User. It is the sole responsibility of the User to provide and maintain a connection to the public Internet network. User accepts that the usage of the Online Content Services generates data traffic (up- and downstream) and may result in increased data service fees payable by User.

11.6 Online Content Services may provide data, information or materials supplied and/or licensed by third parties to Licensor. For such materials different terms and conditions imposed by such third parties may apply. Applicable third party terms shall be referred in the "About" section of the Software Product or as part of this Agreement. When first using /

enabling Online Content, User accepts compliance with those third party terms and conditions.

11.7 Discontinuation. Licensor reserves the right to discontinue provision or access to any Online Content Service with or without prior notice to the User. Such discontinuation shall not entail any consequences other than here stated. In case of discontinued Online Content Services that were (i) provided for a pre-paid fee, AND (ii) such fee covers the use of the Online Content Service for a definite term (i.e. pre-paid subscription service), User shall be entitled to a refund proportionate to the term remaining from such definite term from the time of the discontinuation.

11.8. Community Services. Some Online Content Services may be based on data and information uploaded by participating individuals (Users or other persons) or a Database created and maintained by a group of such individuals. Such data may not come from a trusted source and may also be intentionally false or misleading, as Licensor does not have any means to control or verify the credibility or accuracy of such data or the individuals providing the data. Therefore User accepts that community type Online Content Services must be used with extreme care.

By participating in the community by providing data or any information via the Software Product or other means offered by Licensor (e.g. through a website or other software), User shall accept the following:

- (a) Licensor is granted a royalty free right to use the data uploaded, in particular, to modify, display, make available to the public, distribute, copy the data for any purpose;
- (b) User warrants that not third party has any rights that would hinder or render impossible the use of the data as set out in (a) above, and that no third party rights are infringed by uploading the data on those conditions;
- (c) User indemnifies and holds harmless Licensor from any claim from a third party against Licensor due to violation of its rights regarding the uploaded data.

12 Third Party Terms

12.1 Google Local Search. User acknowledges that Google Local Search (GLS) functionality is provided by the usage of Google, Inc.'s service to the User. User hereby accepts all conditions of Google's Terms of Service provided at <http://www.google.com/accounts/TOS> . User accepts that the Google Local Search is declared "deprecated" and is not commercially supported by Google, Inc. and also it may be made unavailable without notice by Google in accordance with the relevant terms of service at <http://code.google.com/intl/hu-HU/apis/websearch/terms.html> .

8 Copyright note

The product and the information contained herein are subject to change without prior notification.

This manual may not, in whole or in part, be reproduced or transmitted in any form either electronically or mechanically, including photocopying and recording, without the express written consent of Clarion.

© 2011 - Clarion

Data Source © 2006-2010 Tele Atlas. All rights reserved. This material is proprietary and the subject of copyright protection, database right protection and other intellectual property rights owned by Tele Atlas or its suppliers. The use of this material is subject to the terms of a license agreement. Any unauthorised copying or disclosure of this material will lead to criminal and civil liabilities.

All rights reserved.